



# PACKAGING & DIELINES

## *II.*

THE DESIGNER'S BOOK  
OF PACKAGING DIE LINES.

# CONTENTS

|                    |     |
|--------------------|-----|
| SHOPPING BAGS      | 5   |
| RIGID BOXES        | 19  |
| FOLDING BOXES      | 45  |
| GIFT CARD CARRIERS | 103 |

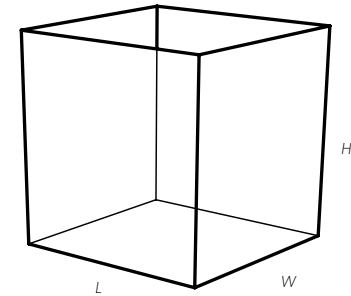

# LEGEND

Trim Line



Fold Line

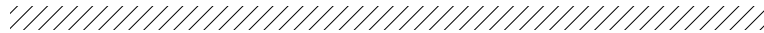

Glue Area

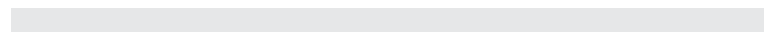

Self Adhesive Strips



Grey Board



Guest Contribution

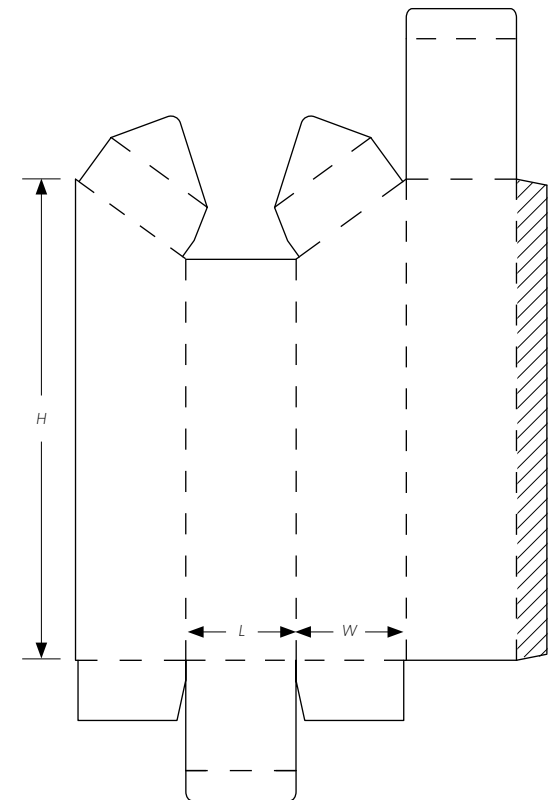

# HELLO

We couldn't be more excited to bring you the next installment of the Packaging & Dielines resource. The team at Design Packaging whole-heartedly believes in the value of collaboration, and the generosity of idea sharing. Our explorative process is driven by innovation and evolution; through sketching and structural packaging mock-ups we define brand appropriate unveiling processes.

Many of our packaging explorations in design, geometry, and unveiling are edited from final presentations. So much so that we felt compelled to share these unseen structures with the packaging design community. We have also included dielines for many packaging standards, for some of the more common applications that can serve as a starting point to evolve into more complex structures.

We appreciate the support of friend Andrew Gibbs and the global community of designers built around [TheDieline](#). To them we extend our thanks. We hope you enjoy this book and share the inspiration you find within its pages as well.

Thank you,



Evelio Mattos

Creative Director, Design Packaging Inc  
Editor, The Dieline



# SHOPPING BAGS

The embodiment of a brand, its promises, values, mission, can be felt in the tactile qualities of a shopping bag handle, the sound of its paper, and the strength of its structure. Beyond their utilitarian function or service as walking billboards, retail shopping bags communicate their message in a flash through well designed visual cues. We've provided retail shopping bag dielines in the pages that follow. Each template can be scaled to meet your brand's specific needs. We recommend that you always print out the dielines to confirm dimensions, proportions, user experience, and that the structure is what you envisioned prior to applying artwork.

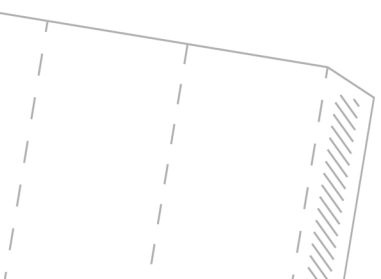

# HOURGLASS SHOPPING BAG

This hourglass figure shopping bag makes a strong visual statement with its angled gussets, and is most effective at smaller sizes. The hourglass shopping bag folds flat just as easily as traditional bags, requiring no additional space at retail.

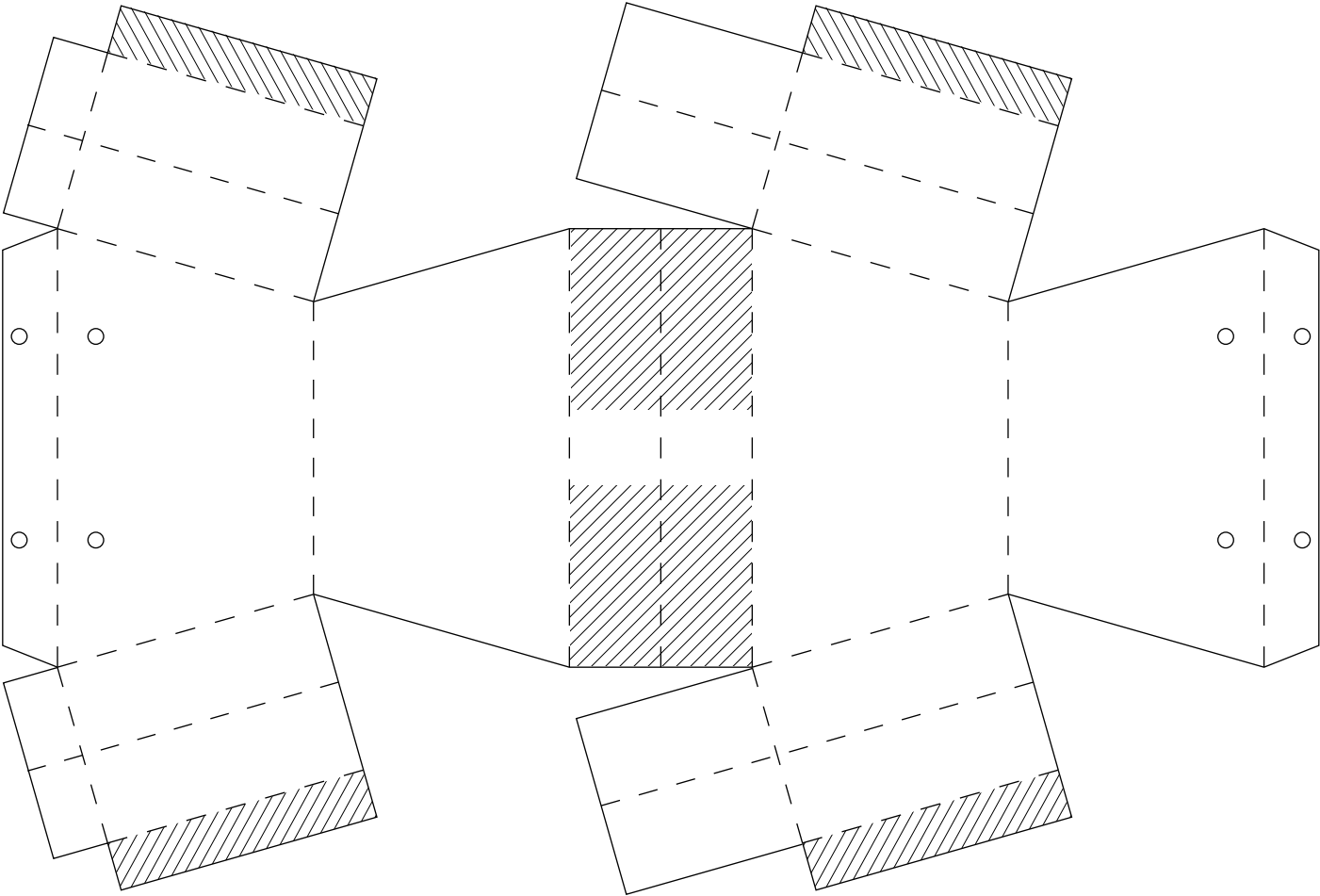



# SATCHEL BAG

The Satchel Bag is a specialty shopping bag echoing the A-frame look of a purse or handbag utilizing a flap closure that tucks shut to protect the product inside.

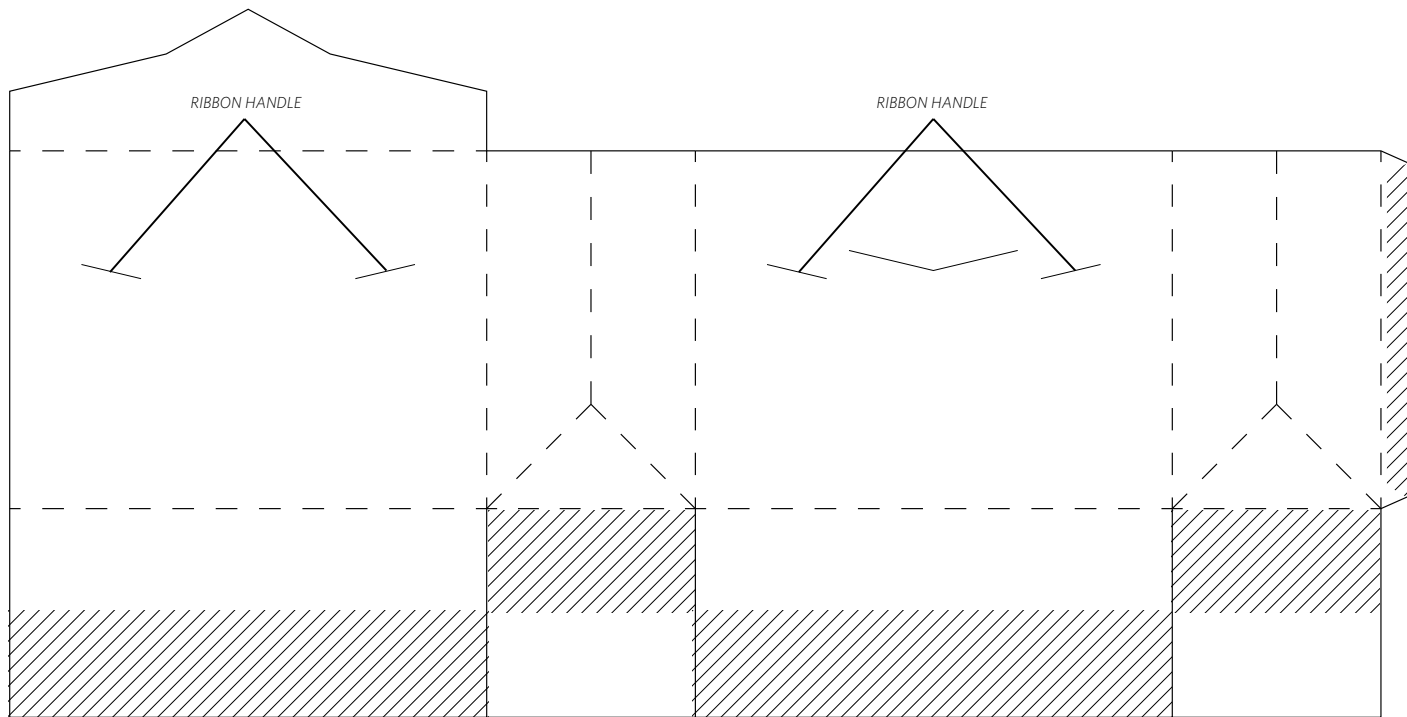





# TUX BAG

This playful retail packaging design with its simple adjustment to the face of the shopping bag, folds out to form a "v", similar to the wing-tip tuxedo collar. Perfect for dressing up retail or event packaging any night of the week.

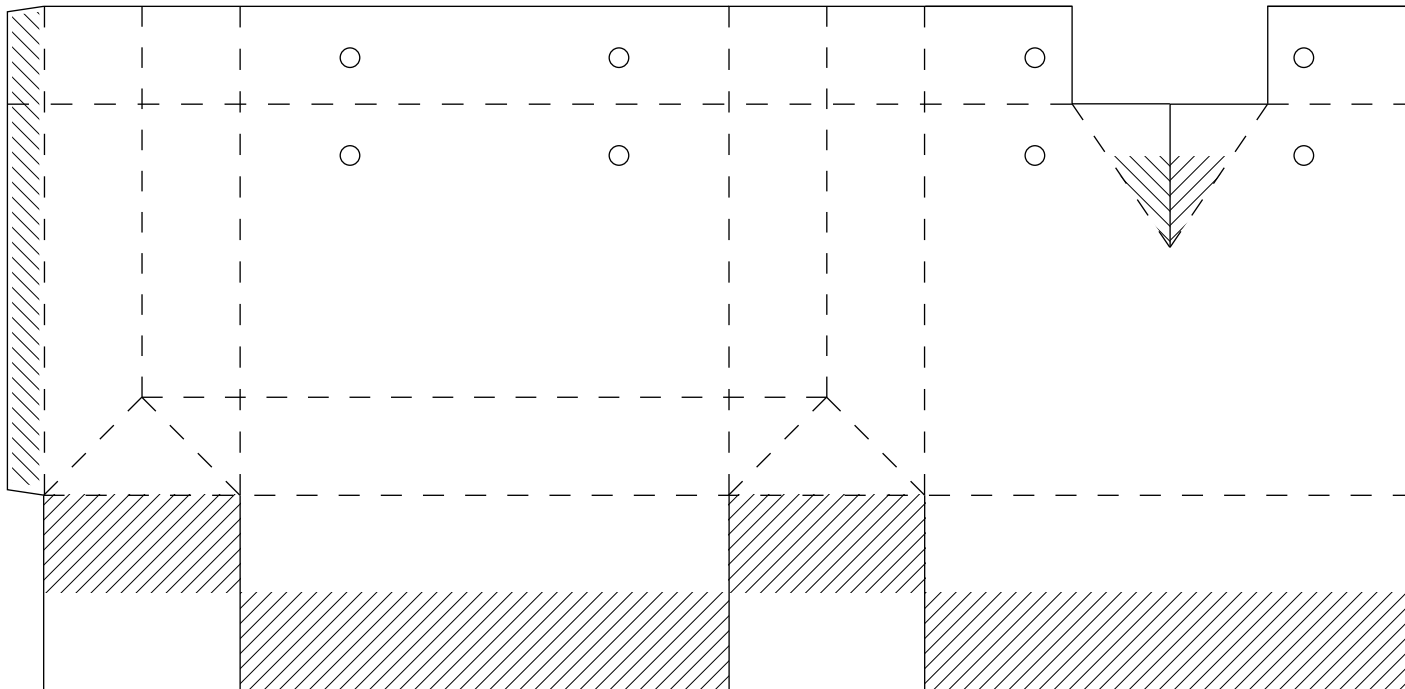



# WINE BAG

The streamlined aesthetic of this retail shopping bag design holds a single bottle of wine. Maintaining its elegant slender shape, and v-cut top, a single ribbon handle draws focus to this wine packaging's contemporary profile.

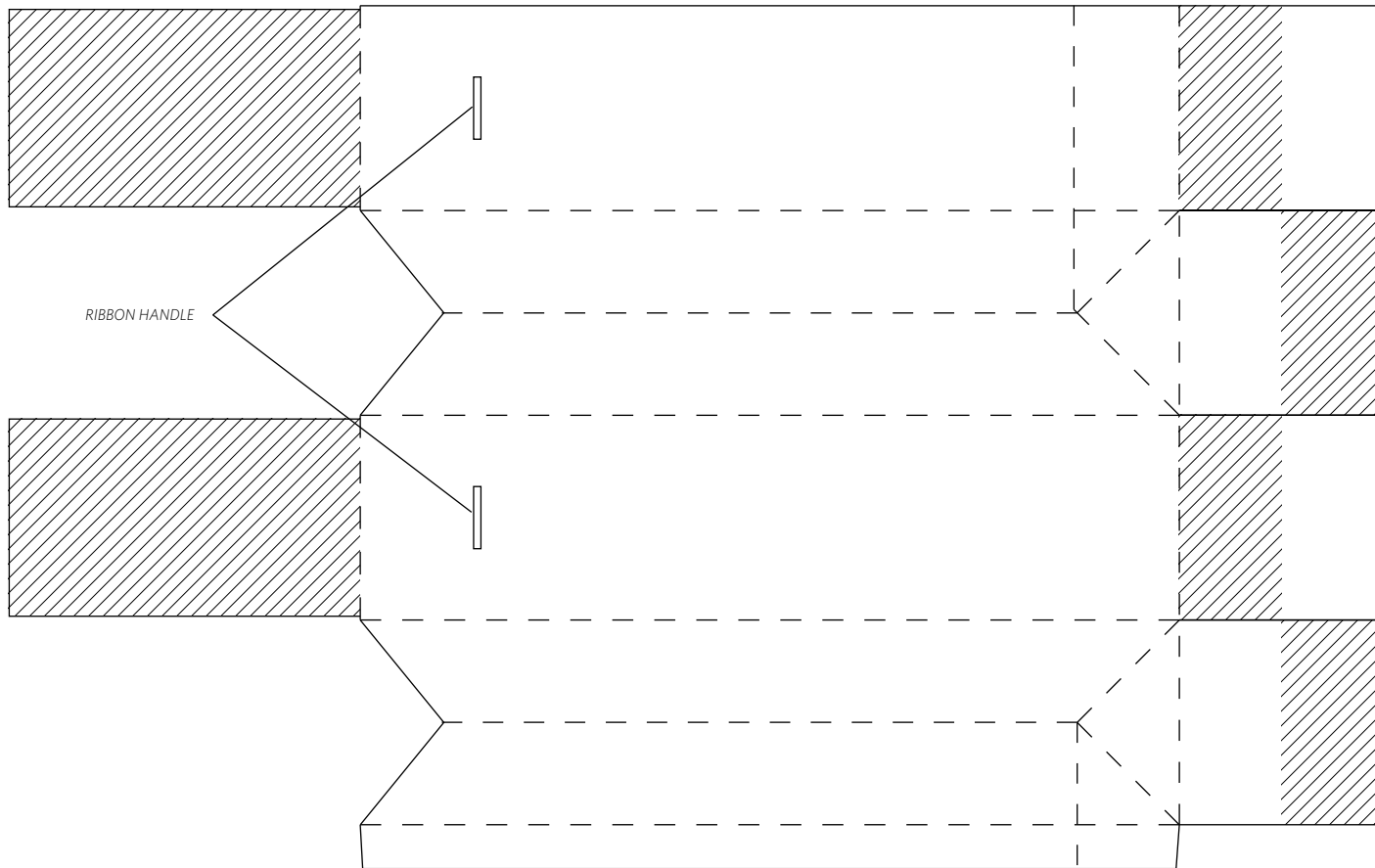



# DIECUT HANDLE SHOPPING BAG

This variation of a Die-Cut Handle Shopping Bag gathers to create an ergonomic handle without pinching the product within.

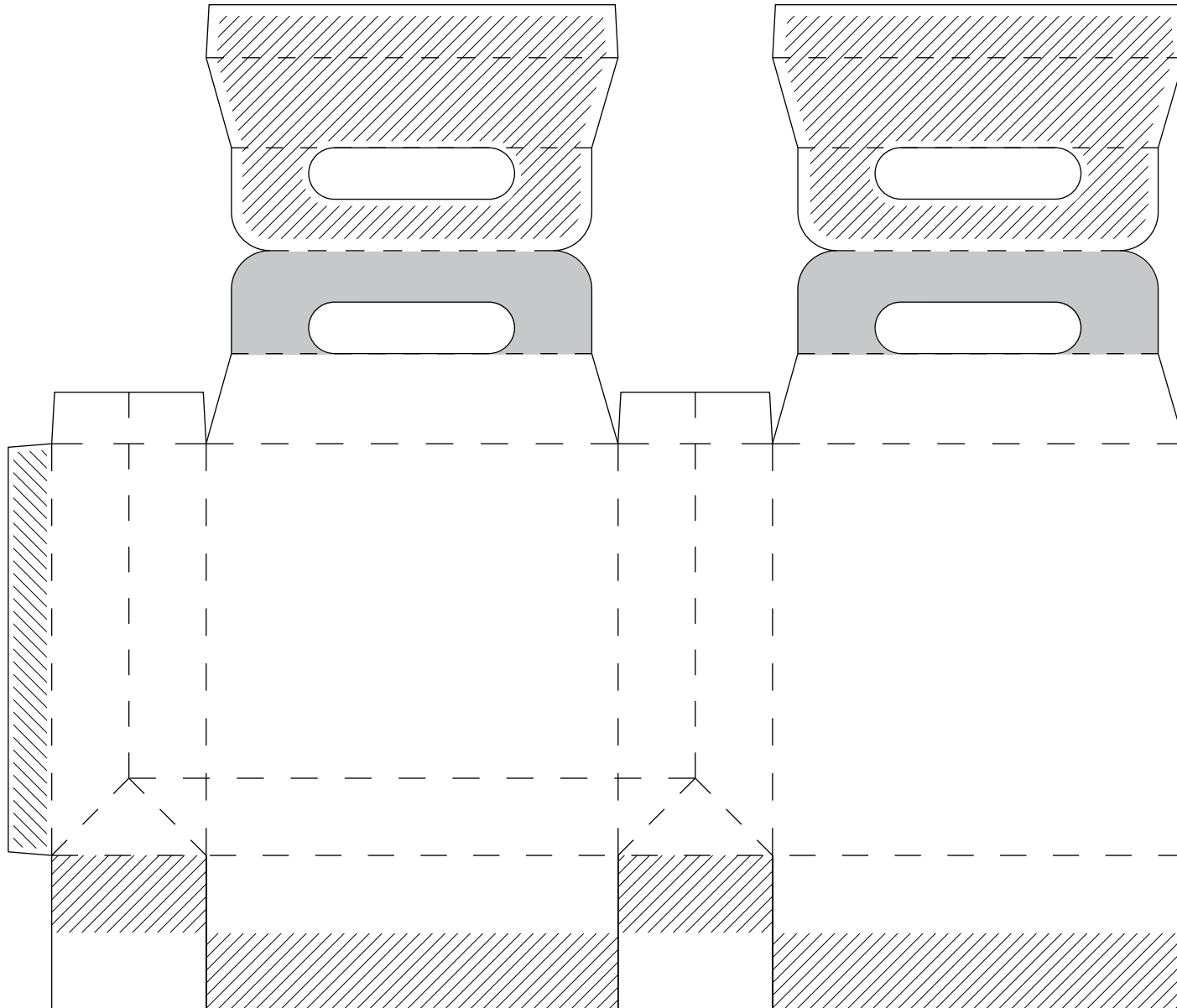



# ANGLED DIECUT HANDLE BAG

This Diecut Handle Bag is working all of its angles from the reverse trapezoidal construction to the distinctive triangular diecut handles. It's sure to make the ordinary retail shopping bag green with envy.

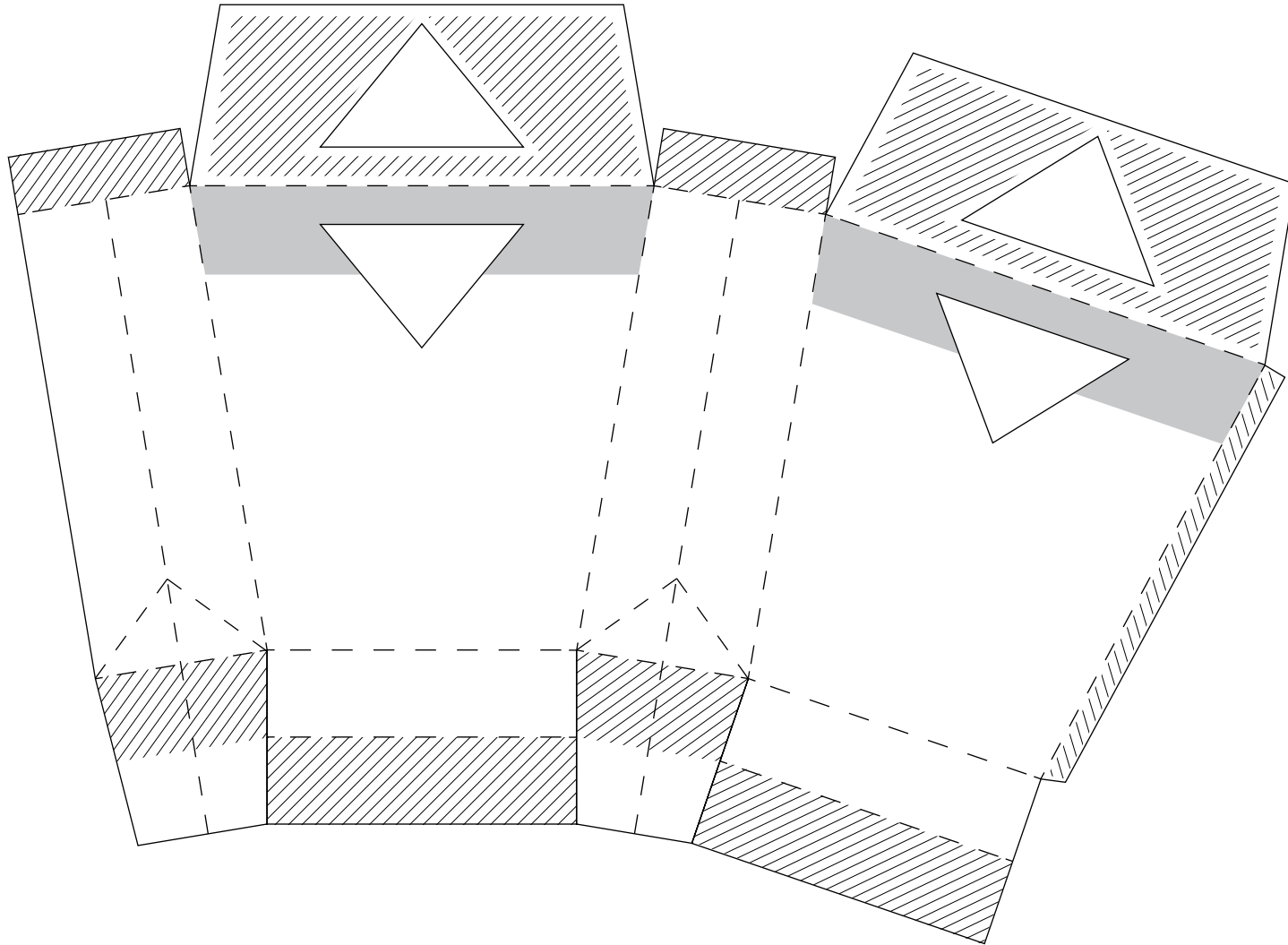







# RIGID BOXES

Rigid boxes are a staple in luxury retail or product packaging because of the weight, strength, and firmness conveyed by their structure. These dielines for rigid boxes, focus on the paper wrap that is applied over the exterior of the grey board that gives the boxes their structure. The interiors of rigid boxes are often wrapped by a paper liner that carries a consistent look and feel throughout the unboxing experience. We recommend that you always print out the dielines to confirm dimensions, proportions, user experience, and that the structure is what you envisioned prior to applying artwork.

# RIBBON-LESS DRAWER BOX

Sometimes a ribbon pull just won't do. This packaging design features a cutaway tab on the sleeve, eliminating the need for a ribbon and providing a slightly more masculine feel. Its streamlined profile is a perfect solution for minimalist packaging design.

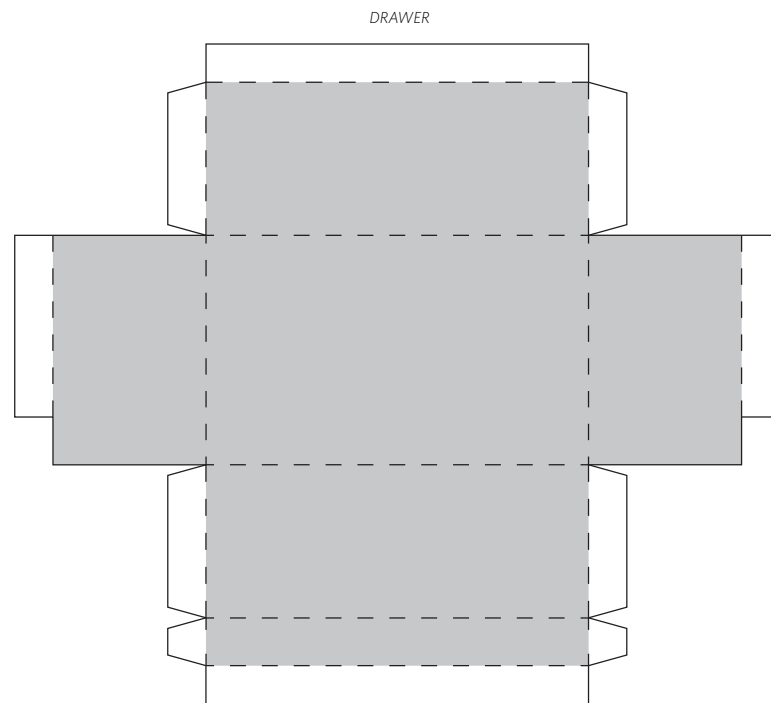
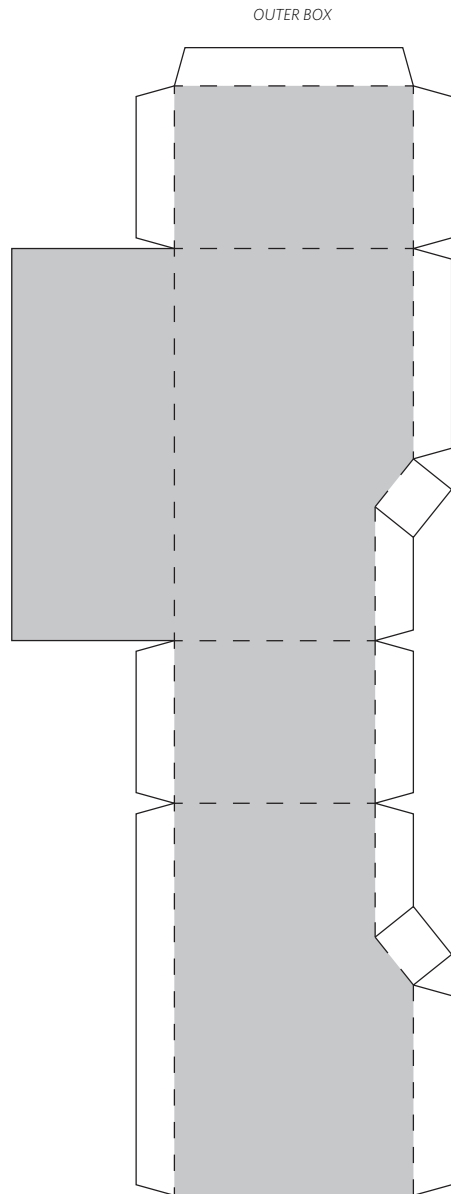

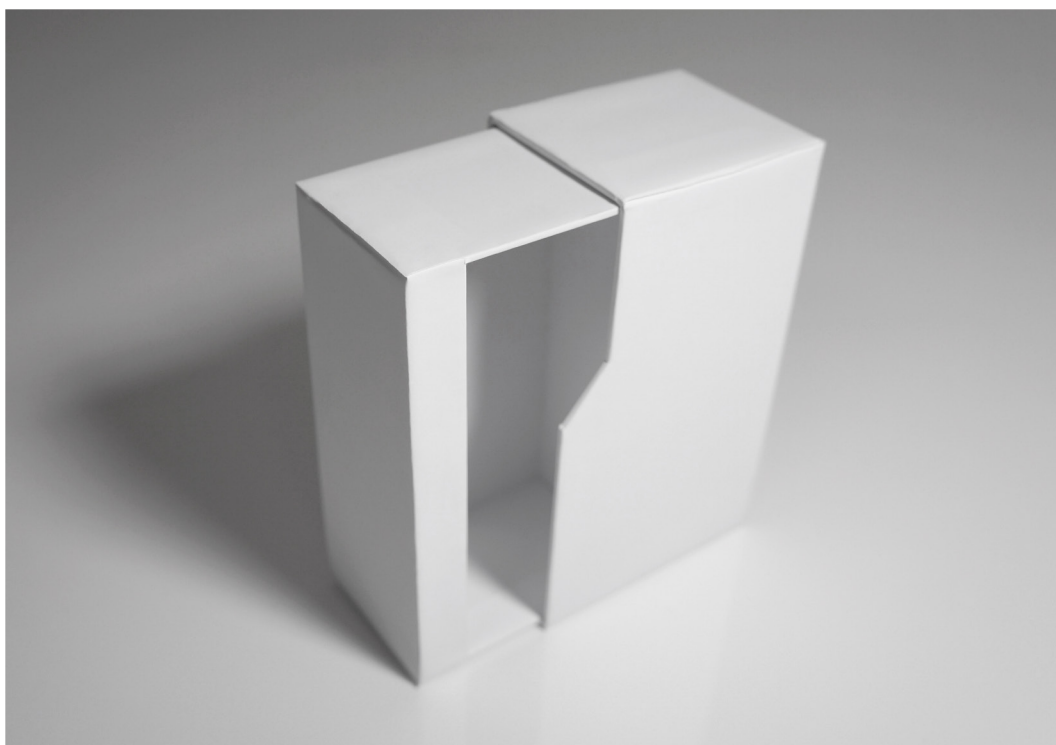

# POP-UP DRAWER BOX

The seemingly normal drawer box, is anything but. When pulled open this packaging design utilizes a hidden ribbon to raise the interior lid, creating a memorable moment of delight in the user's unboxing experience.

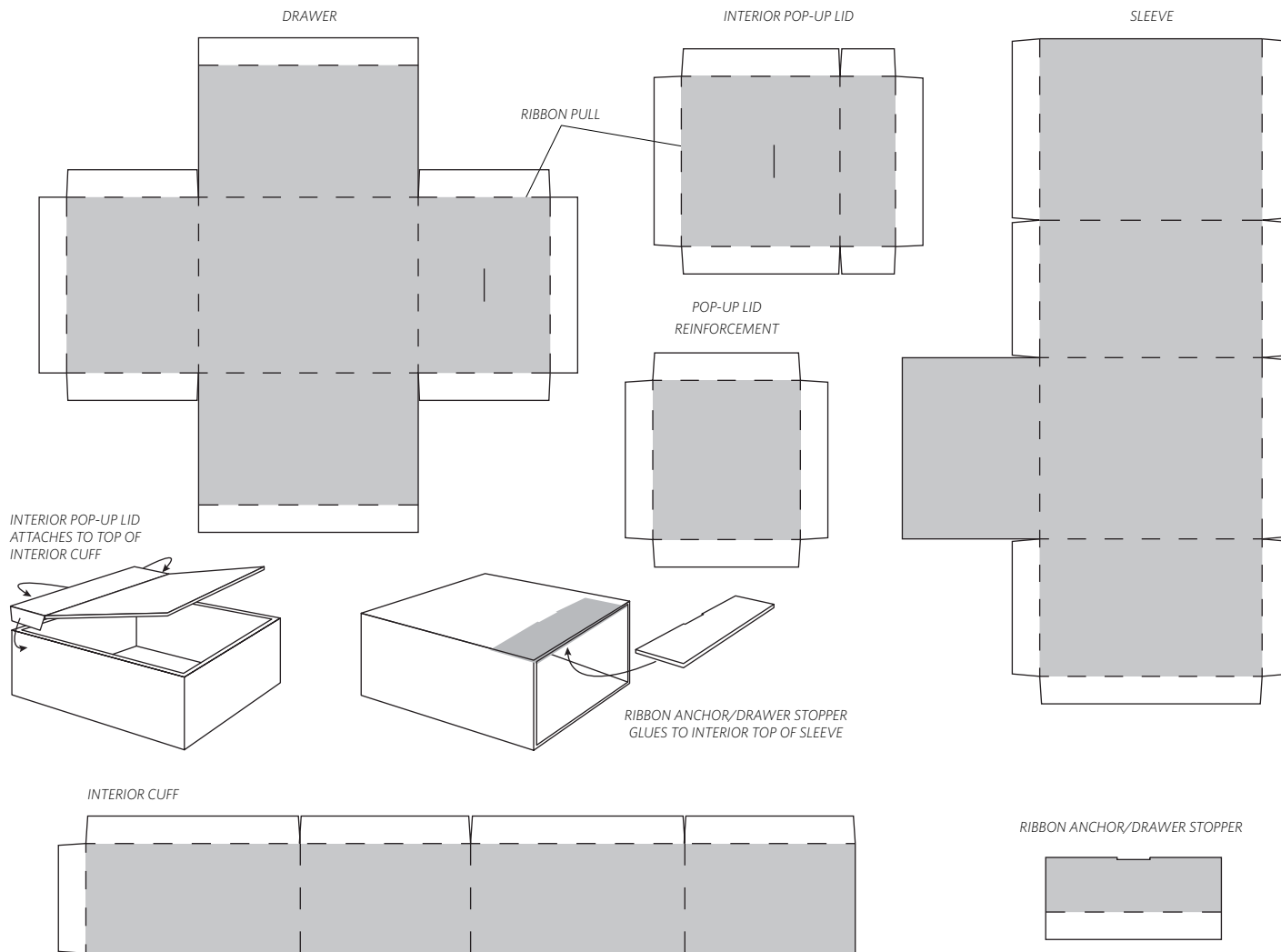

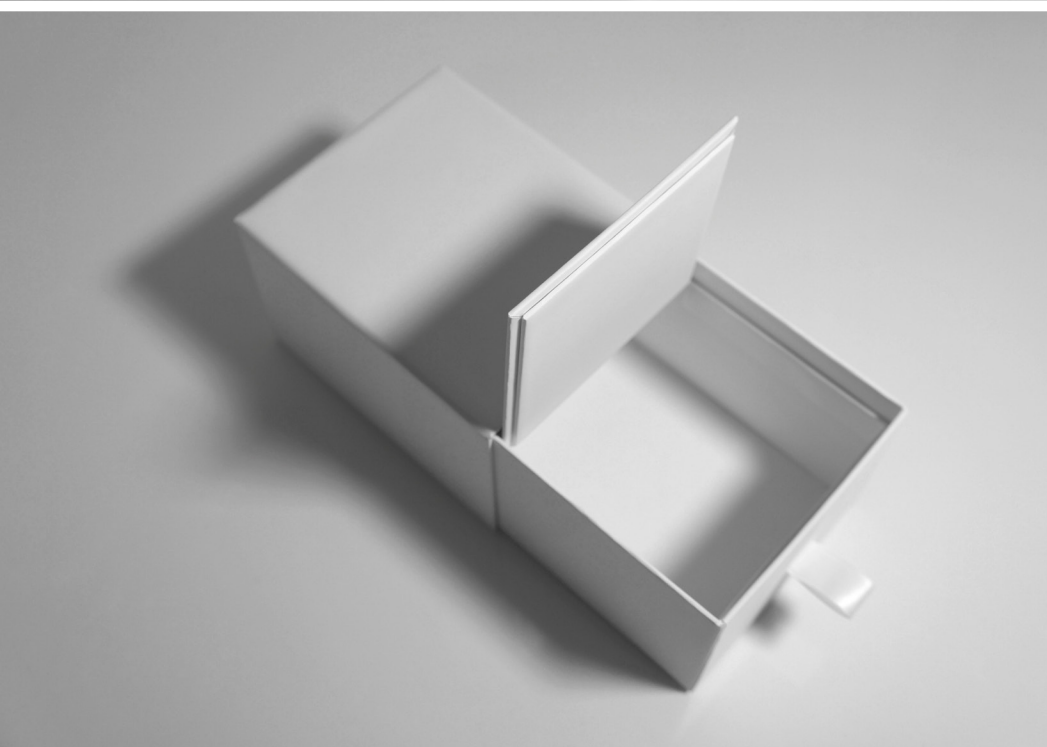
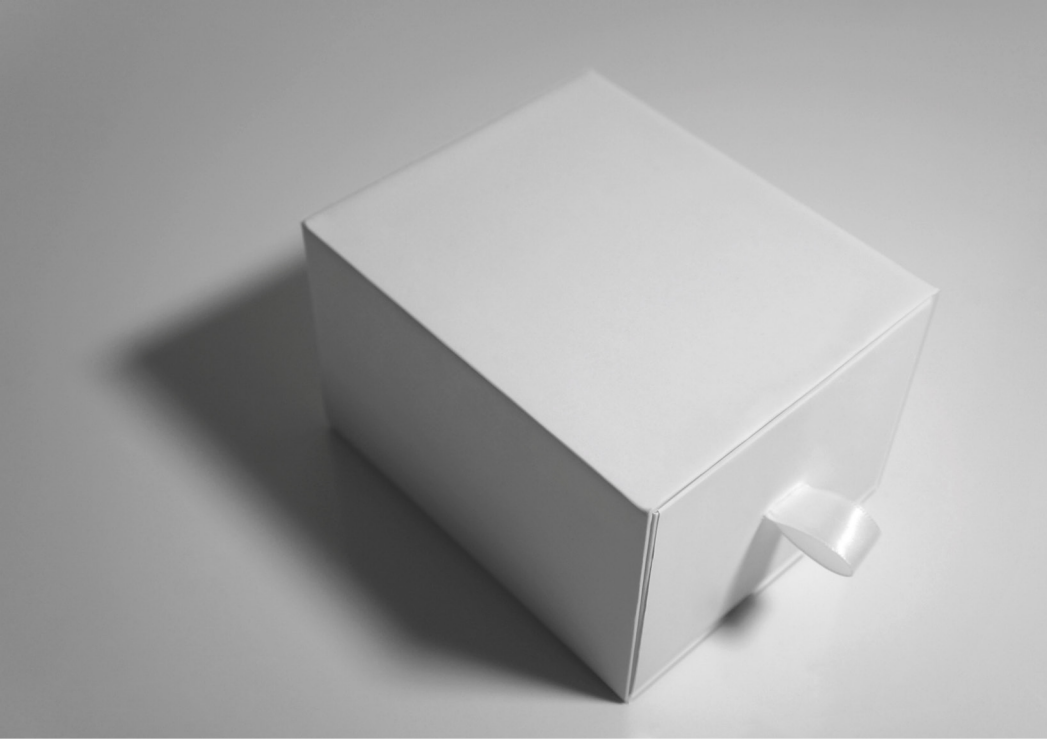

# 3-DRAWER BOX

This product packaging design's hinged doors swing open to reveal multiple drawers within. Due to the stackable nature and removable drawers, this compartmentalized concept can serve as the foundation for a reusable modular packaging design.

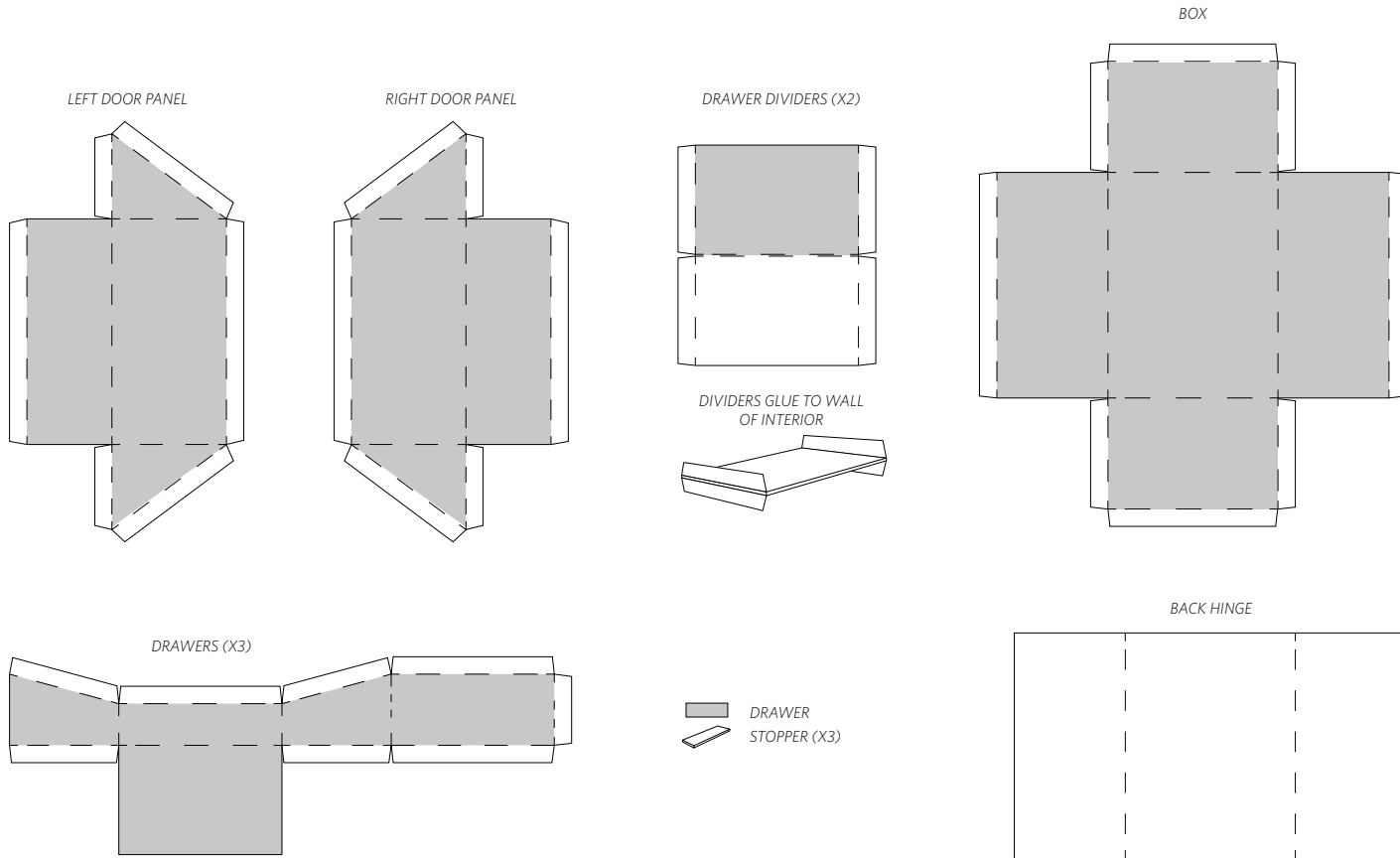



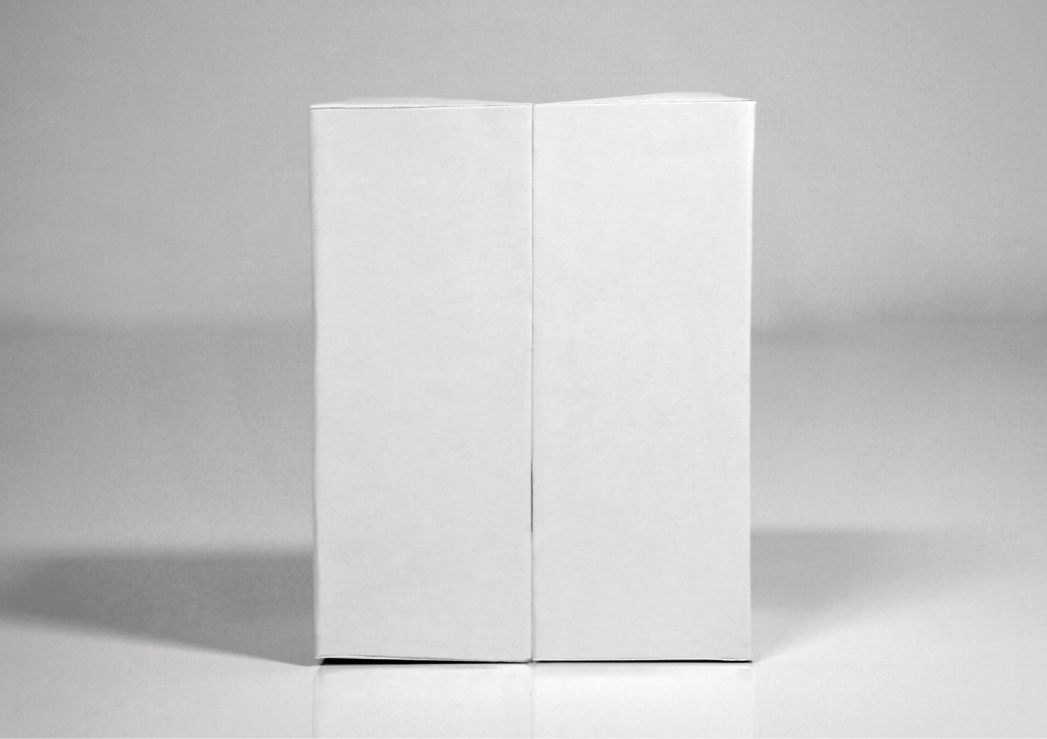

# ZIG ZAG CUFF BOX

A twist on traditional cuffed packaging design, the Zig Zag Cuff Box catches your eye with its chevron-like detail.  
A contrast finish or color in the cuff area provides a memorable shelf presence, and at-a-glance recognition.

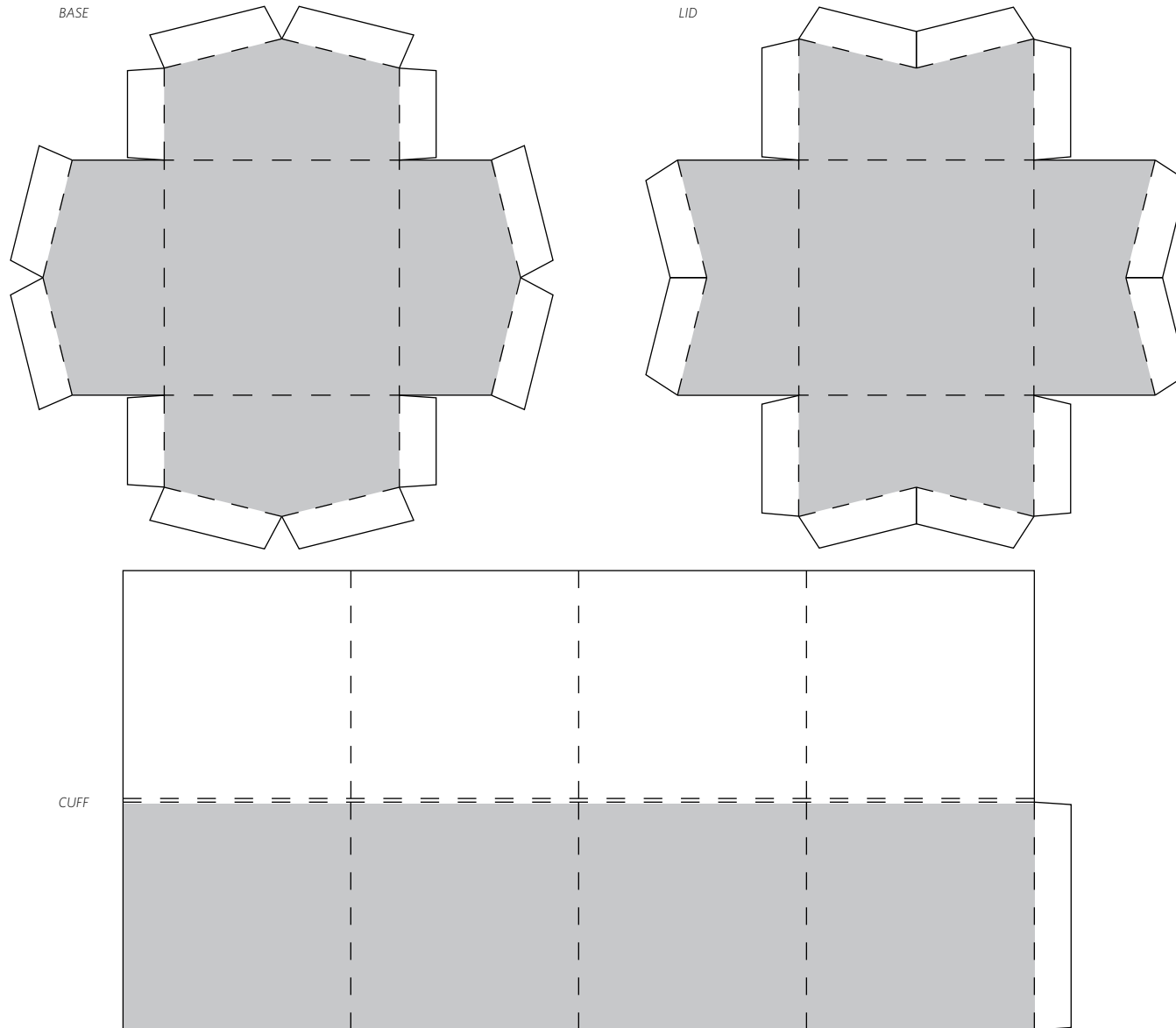

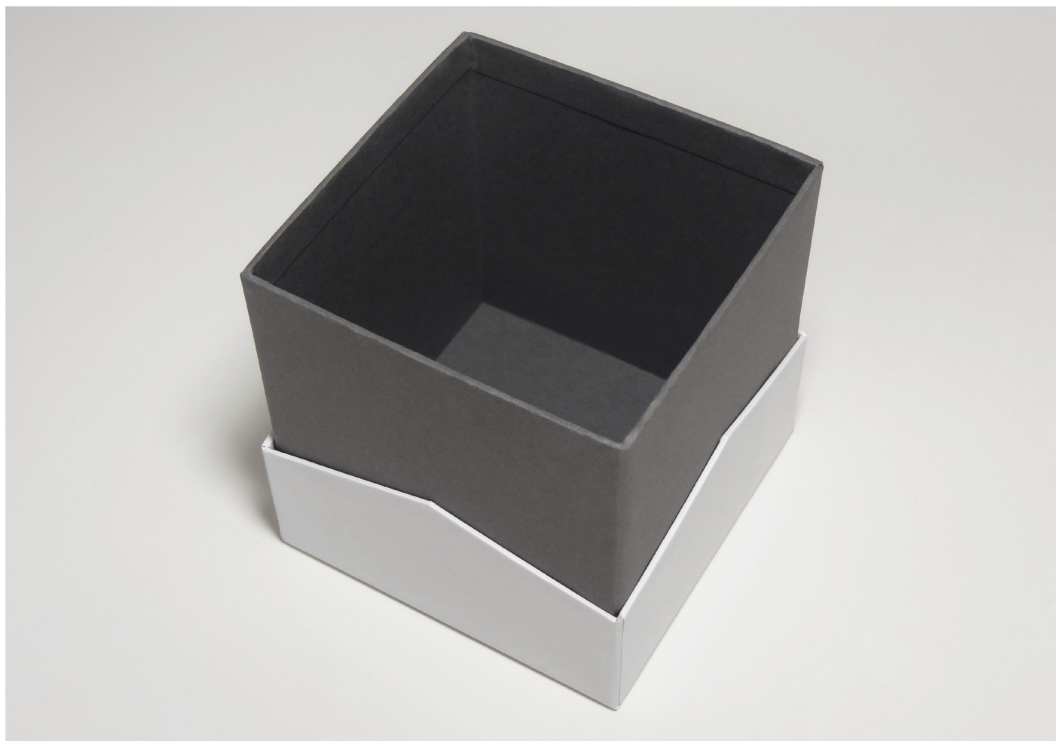
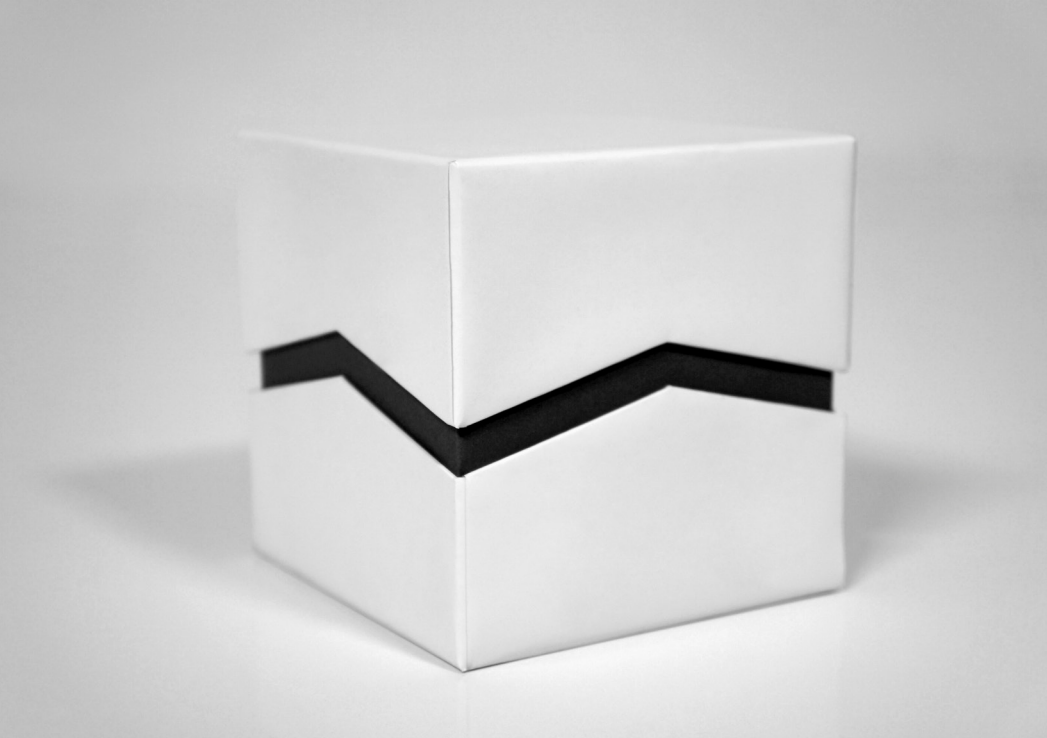

# OBELISK BOX

The erect, angular pillar-shaped product packaging design is reminiscent of Egyptian obelisks. The lid as well as the external cuff, lifts off of the base to reveal a small platform showcasing the product within.

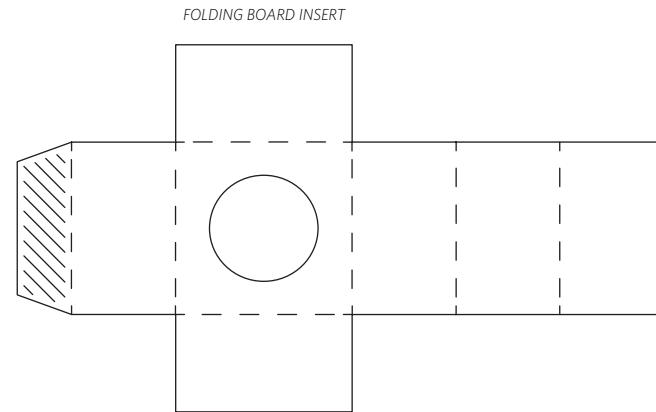
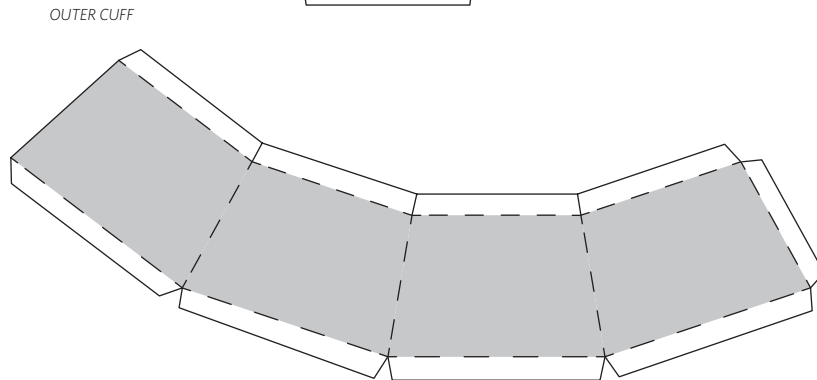
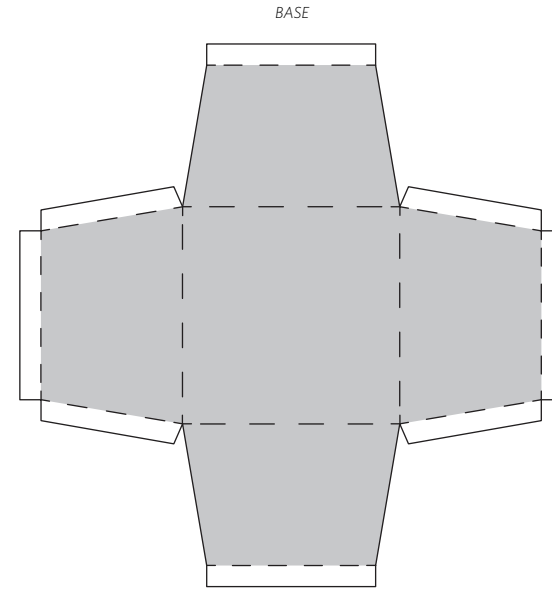
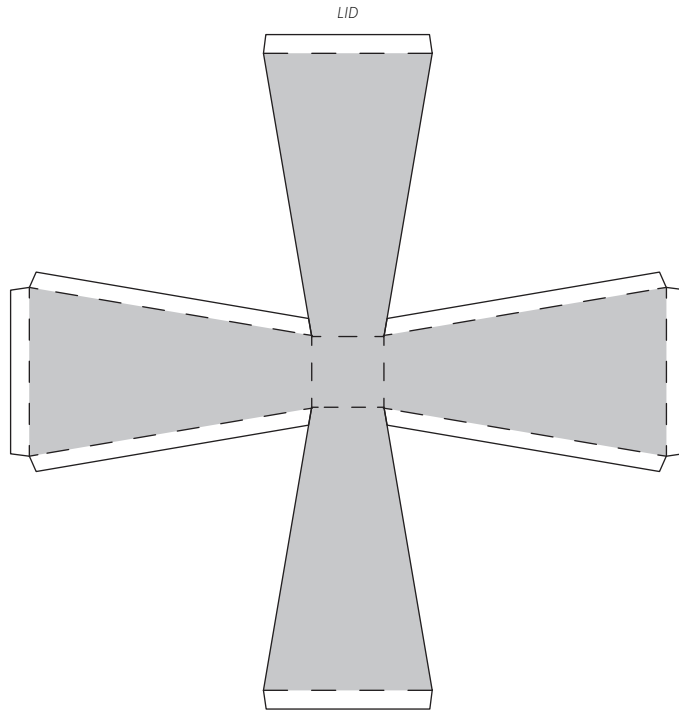

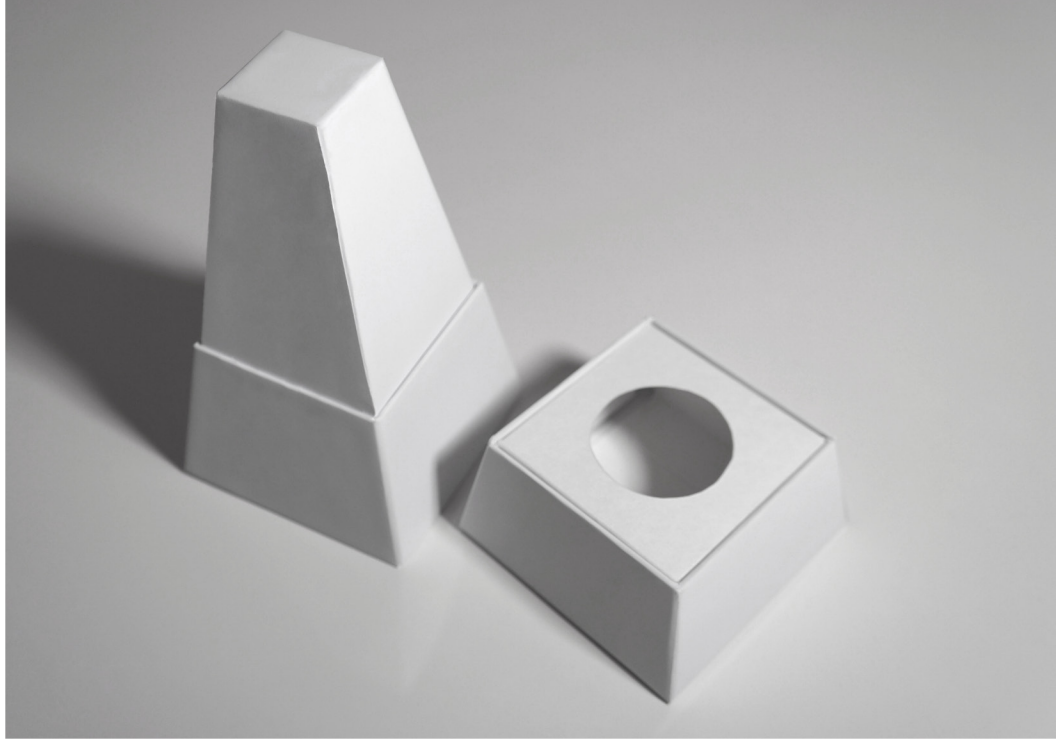
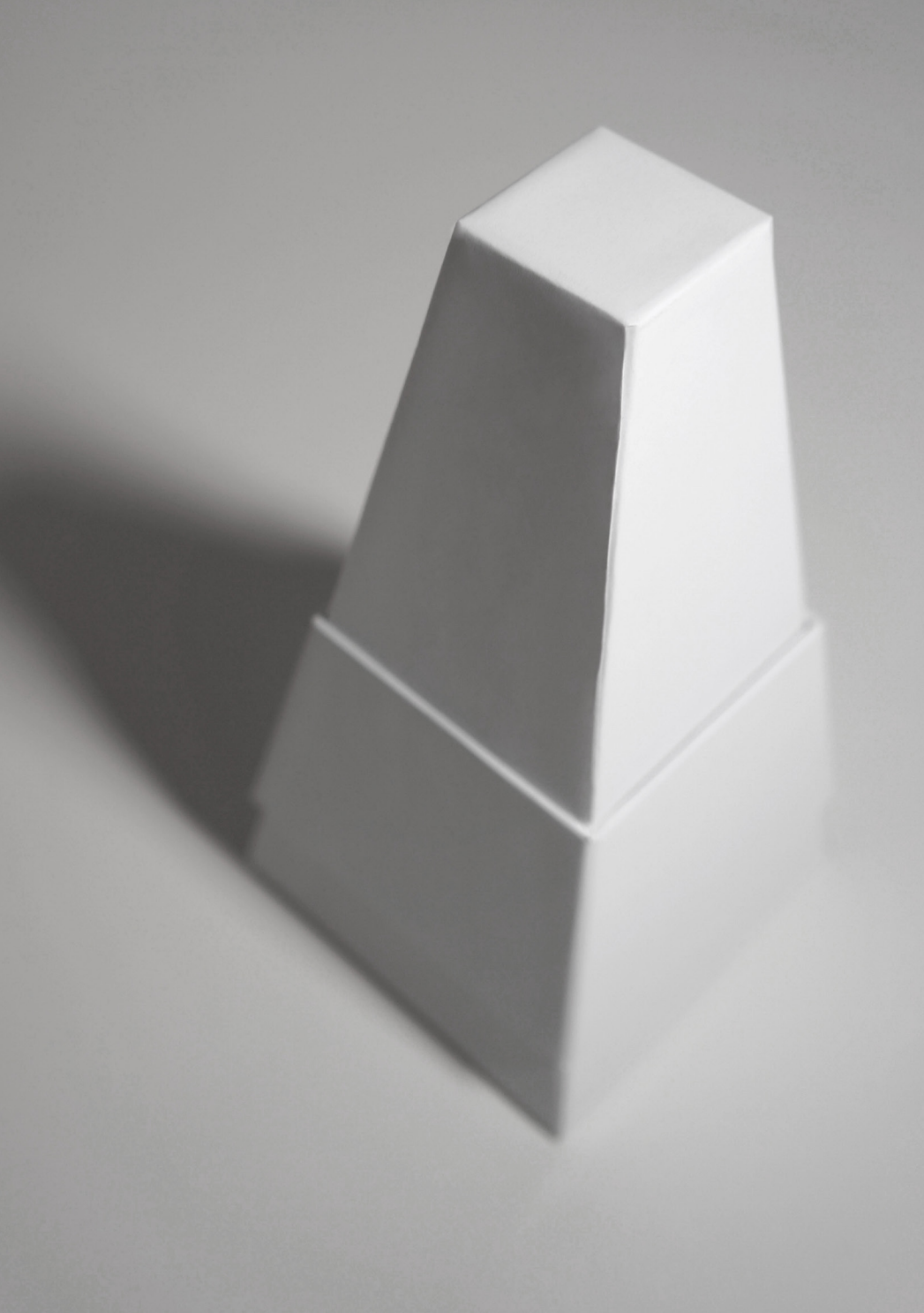

# ROTATING RING BOX

Jewelry packaging design doesn't have to be boring. This interactive packaging design is built to create excitement. When pulled open, the center compartment rotates to reveal the hidden ring within. What's cooler, the ring or the box?

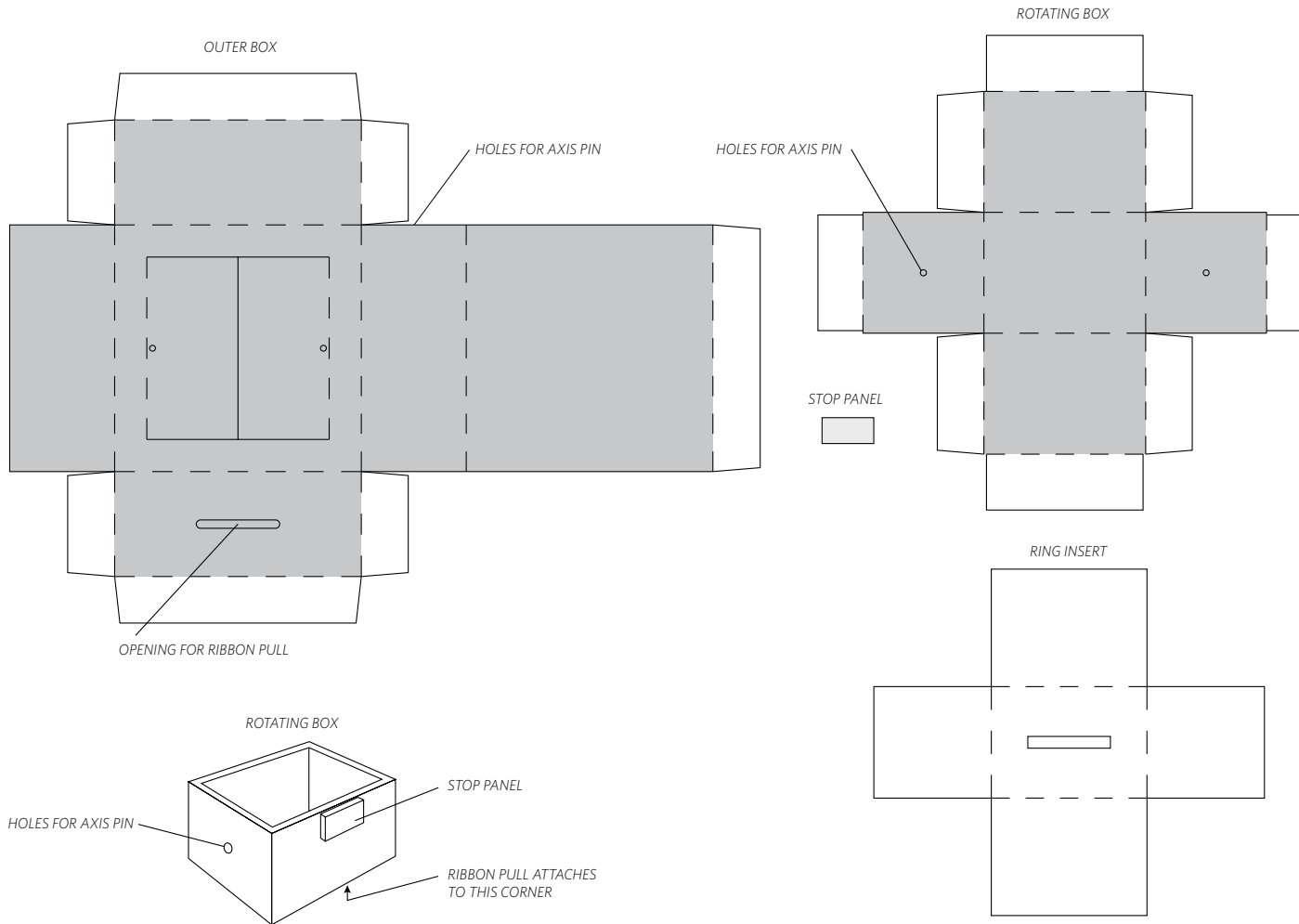

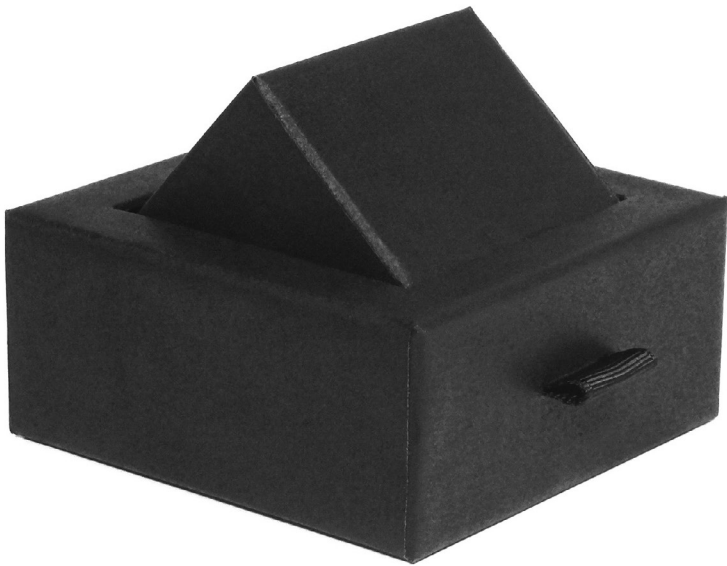
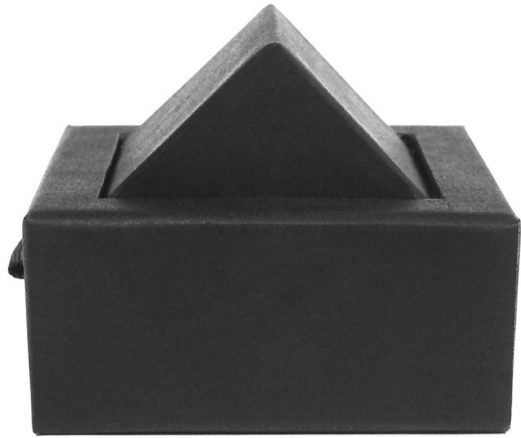

# CHAMFERED BOX

The faceted edges of the Chamfered Box give it a gemstone-like appearance, while maintaining a minimalist aesthetic.

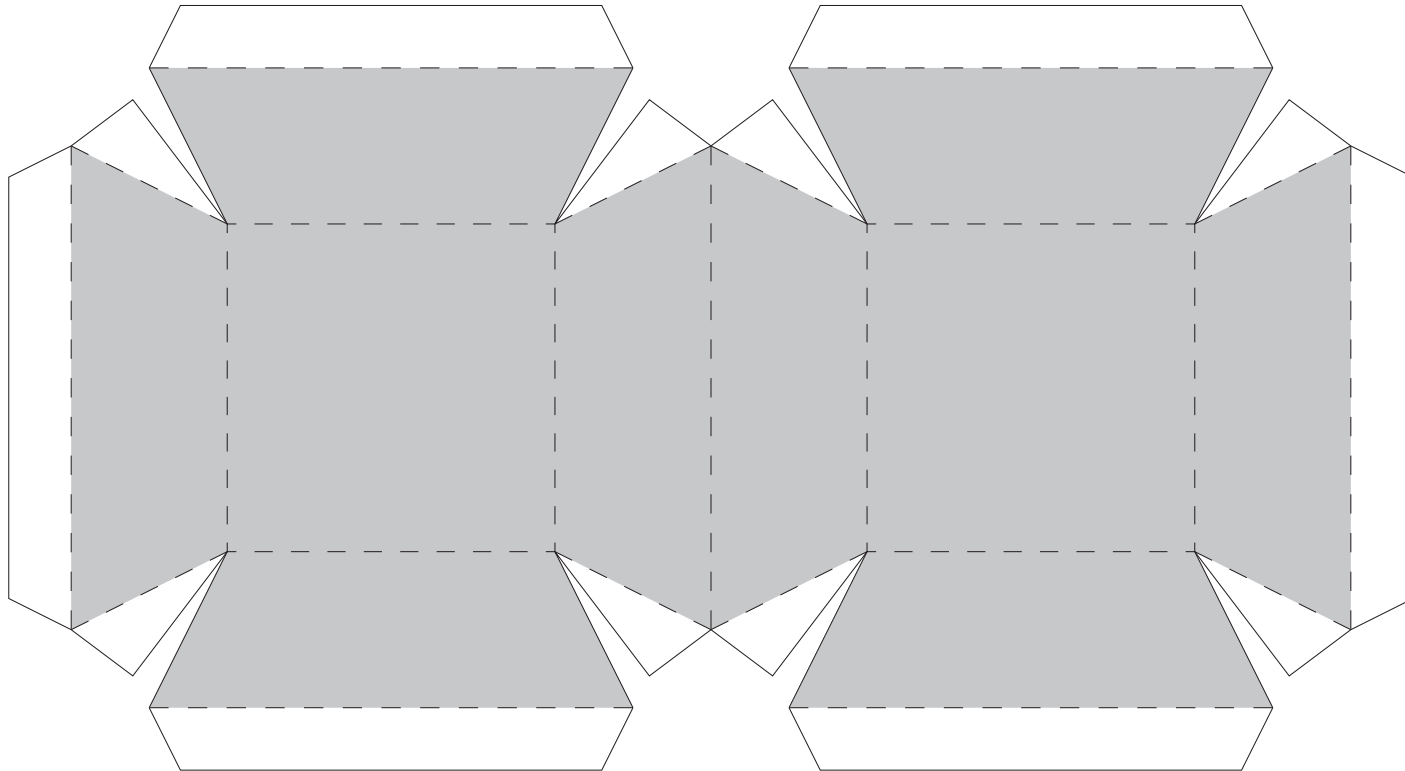



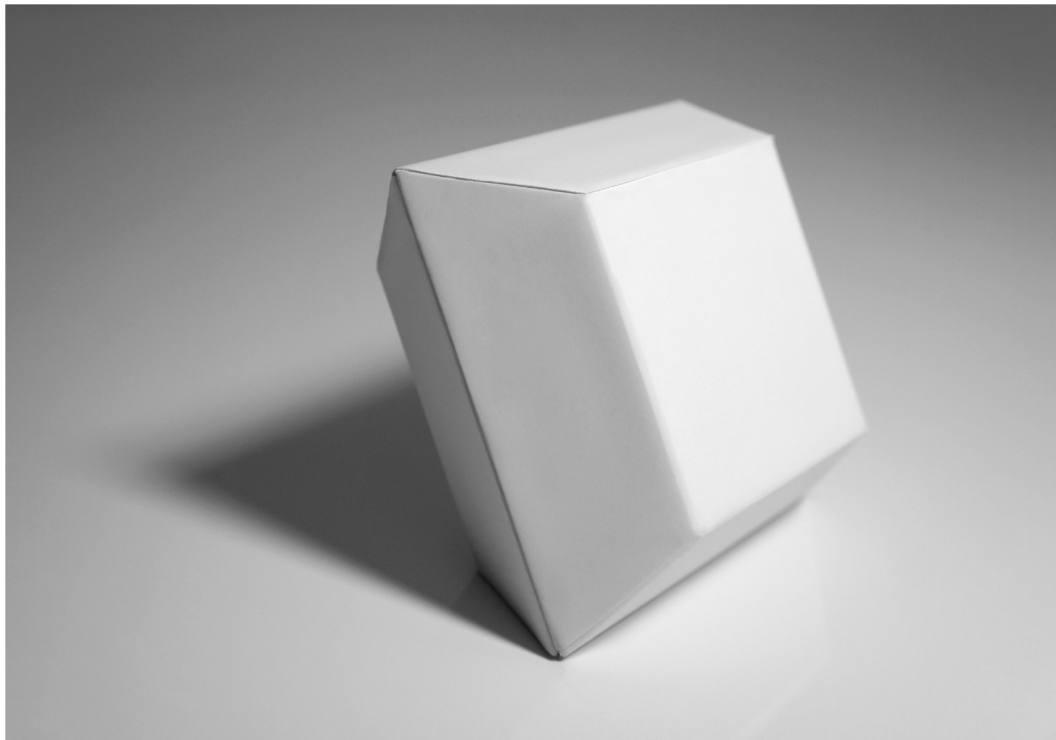
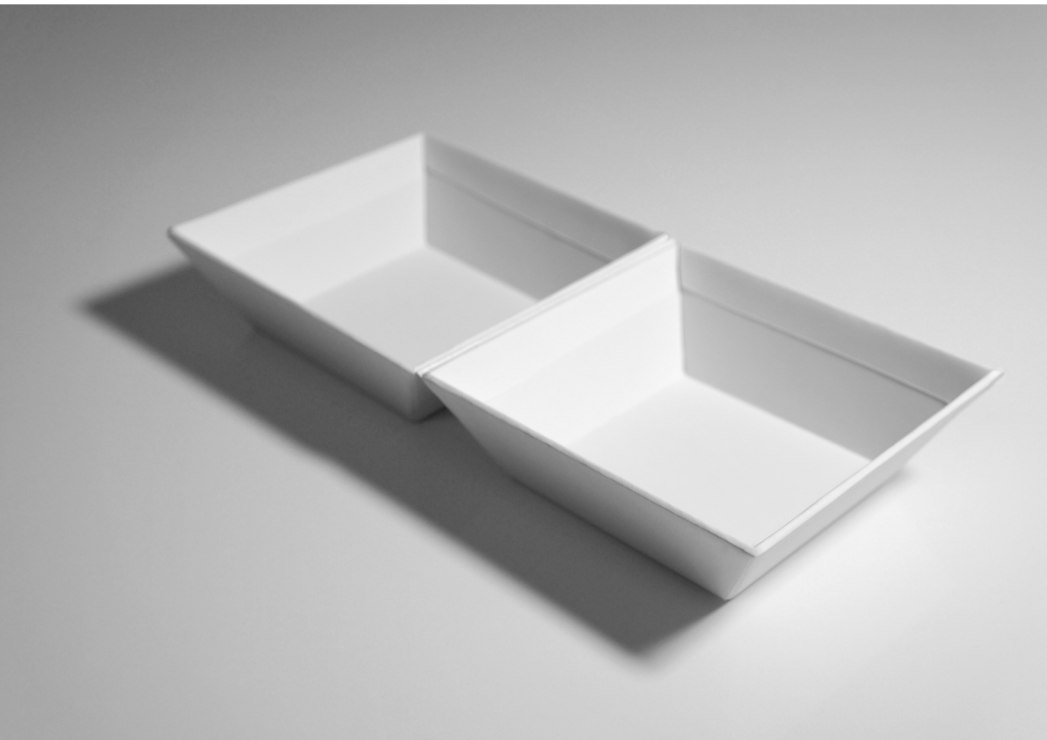
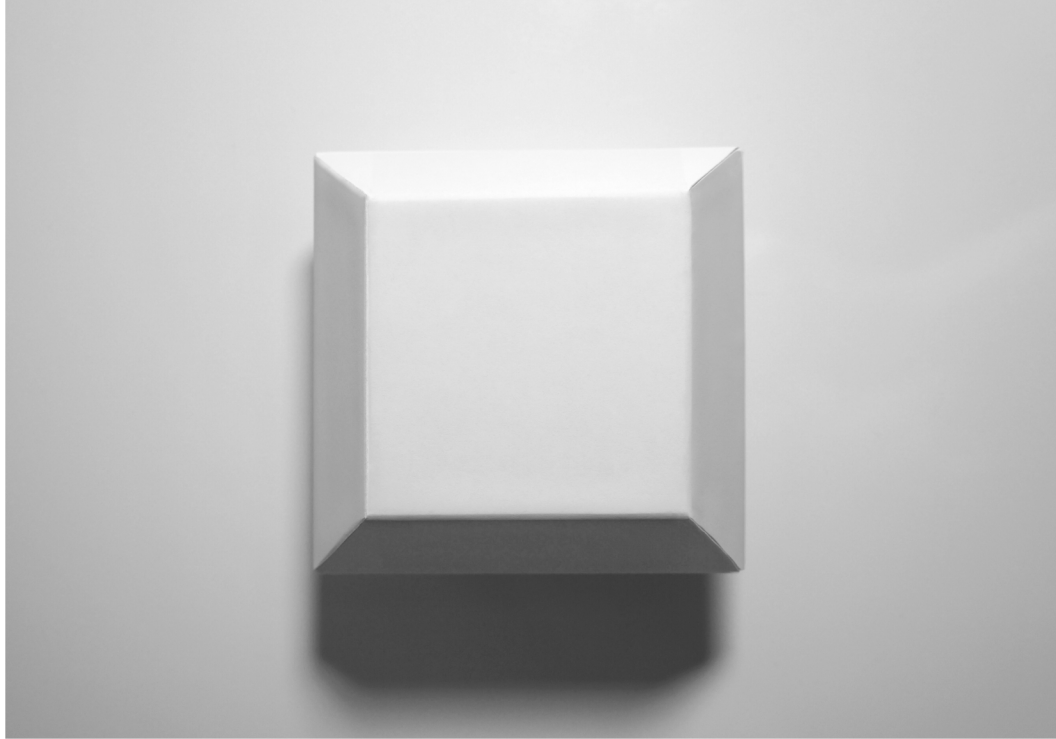

# TRIFOLD BOX

No ordinary cube, this trifold packaging design opens to reveal a main compartment flanked by two supplementary subsections. The hinges dramatically reveal the product all at once, or can be supplemented by a topper adding drama to the unveiling.

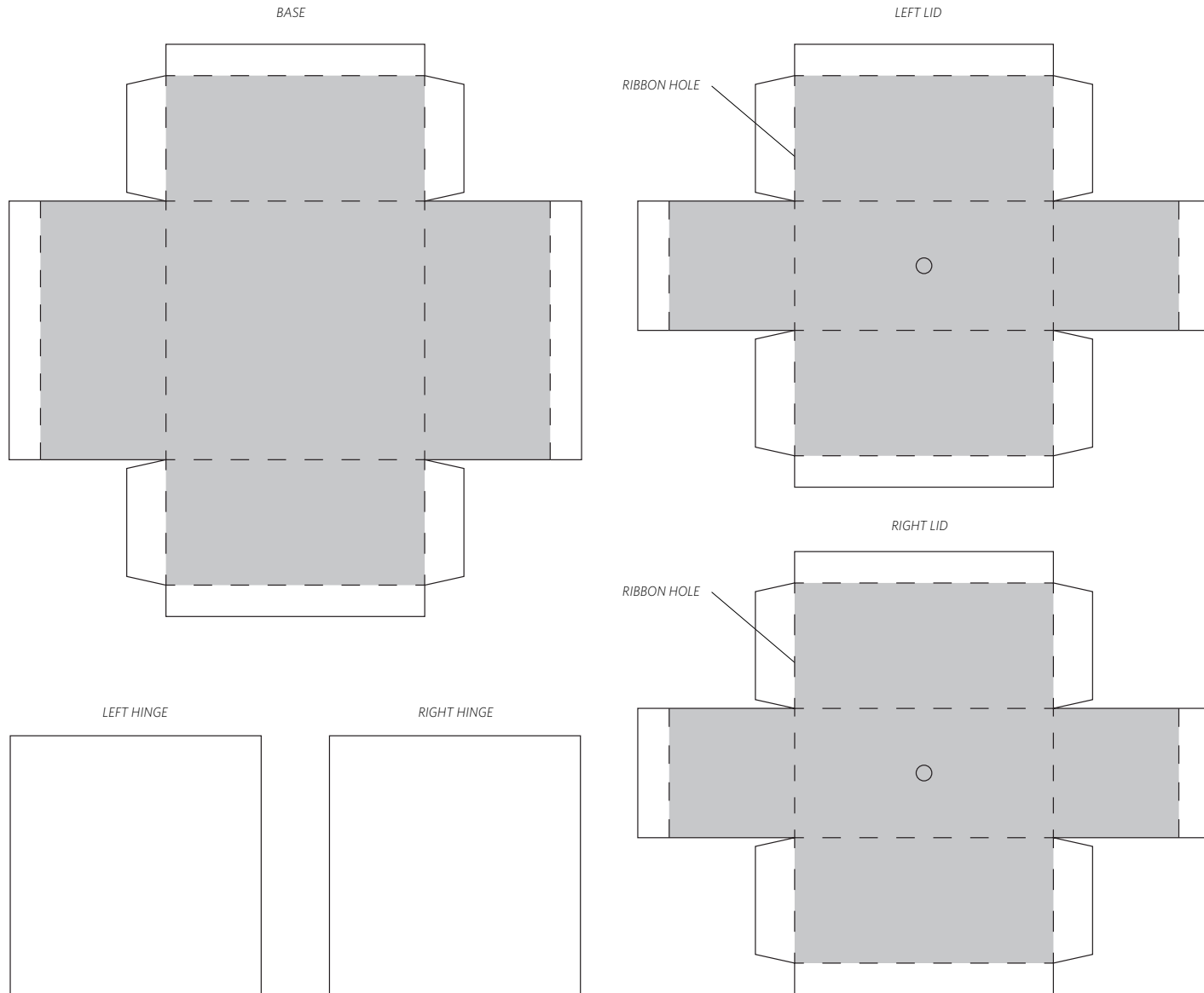

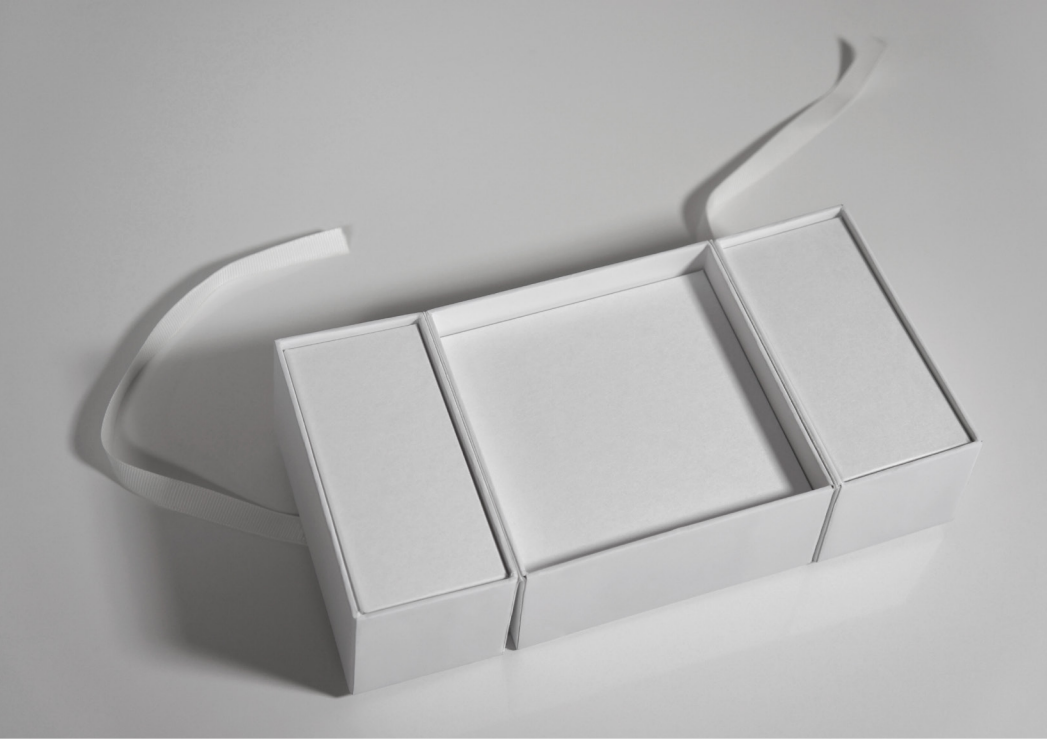

# HINGED TRIANGLE BOX

If Cleopatra needed fragrance packaging to hold her oils, the Hinged Triangle Box would be it. The lid segments of this triangular box are designed to cradle, protect, and dramatically unveil the product as they hinge open.

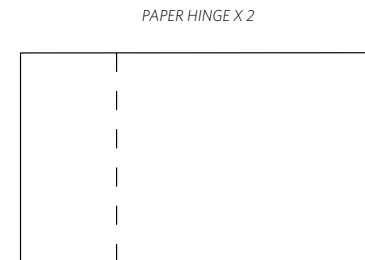
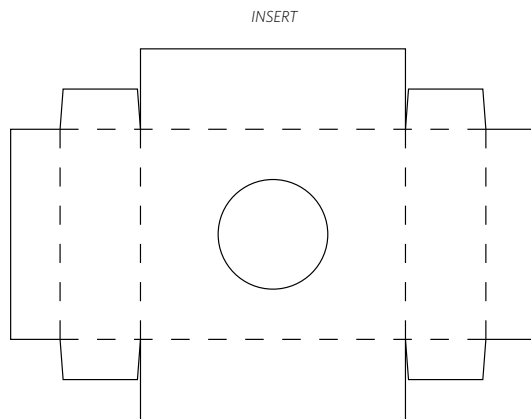
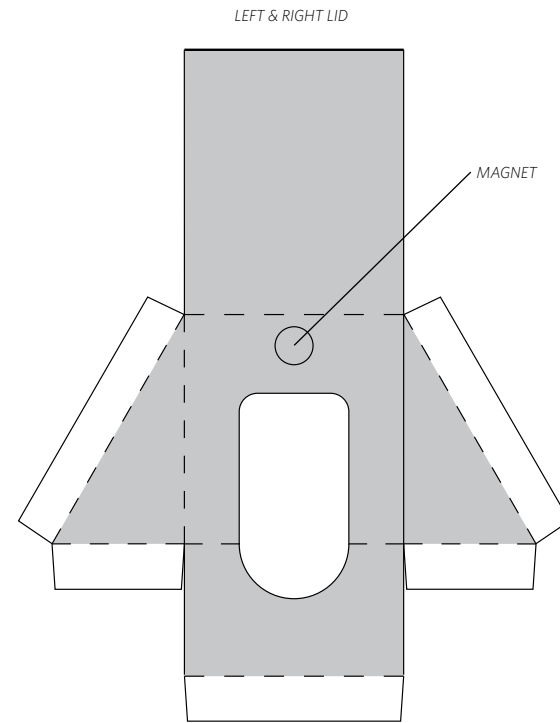
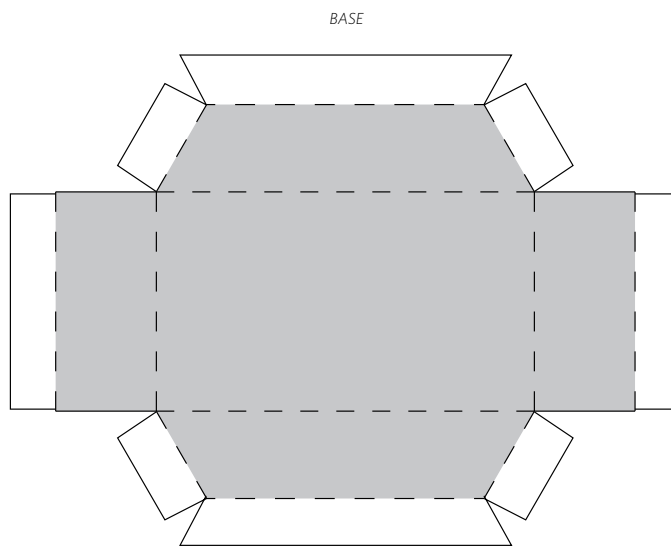

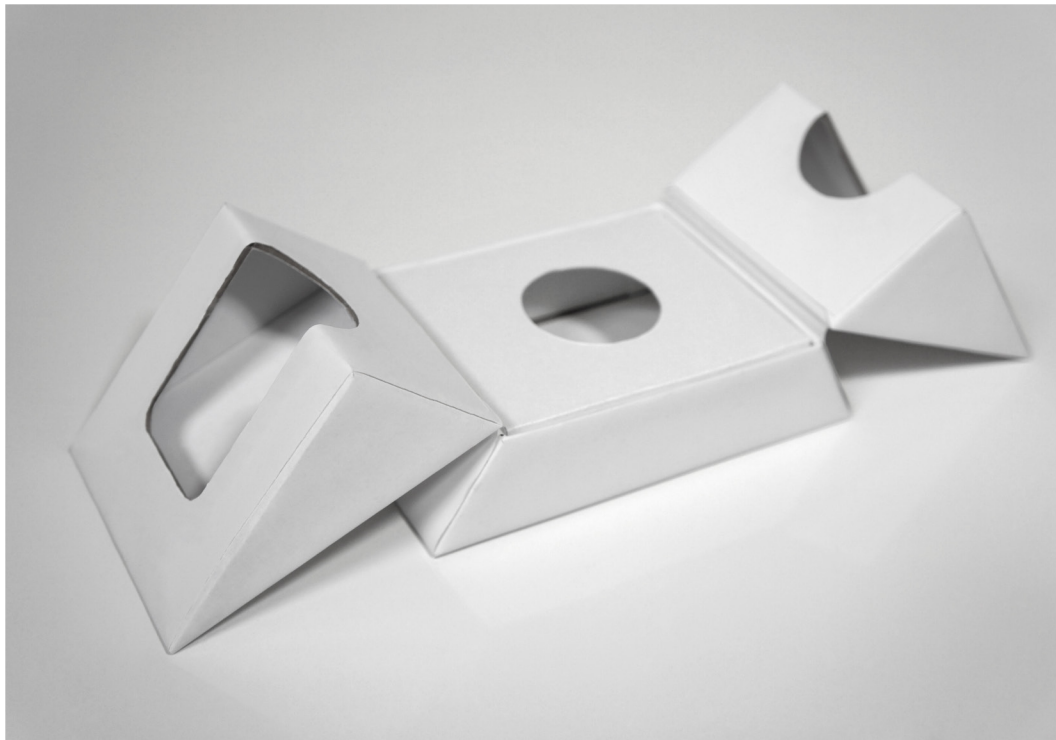
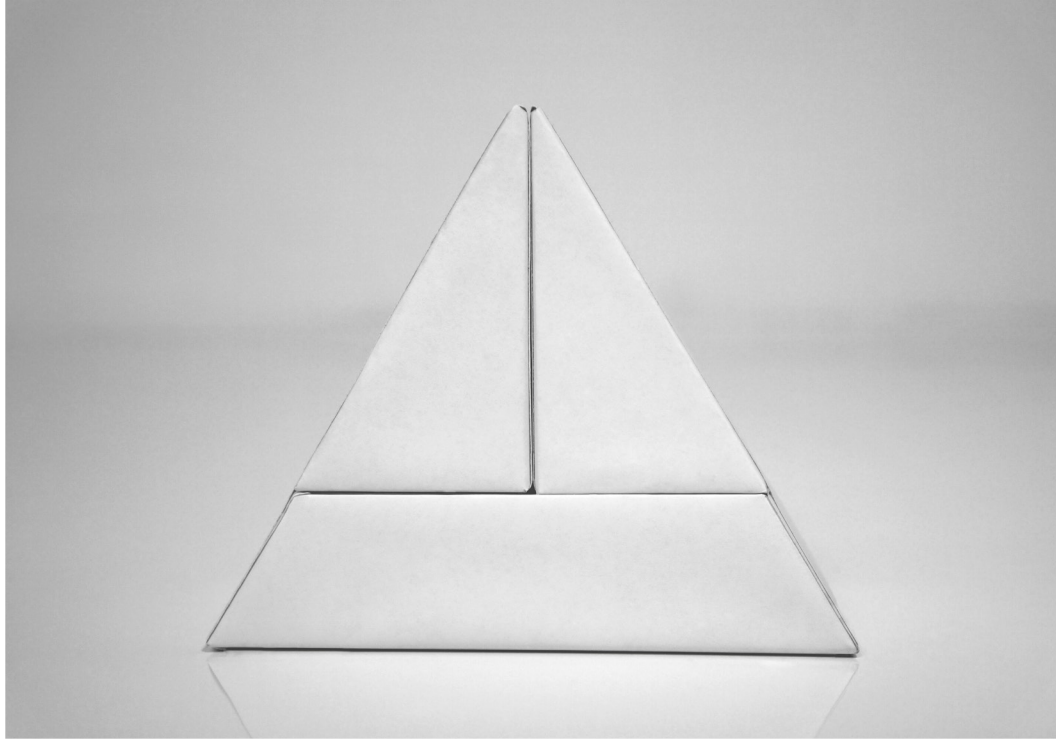
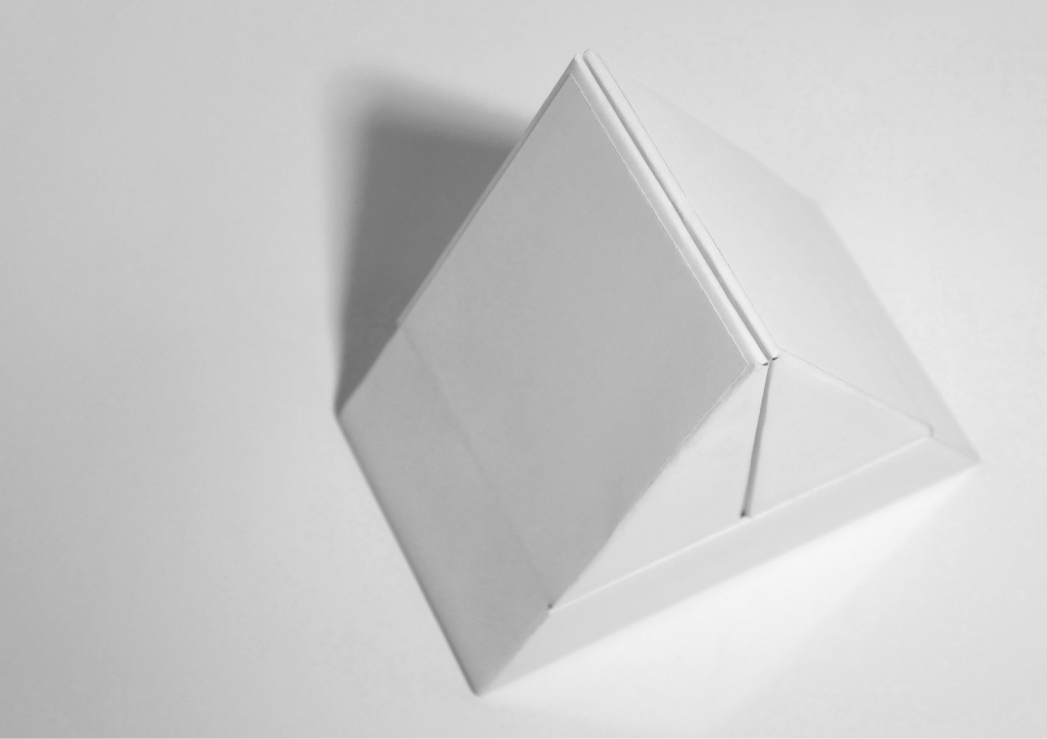

# BOX WITH ANT HILL INSERT

The cone-shaped insert in this packaging design is deceptively simple. Creating a sloped surface that rises to meet the user, it both secures and draws attention to the product.

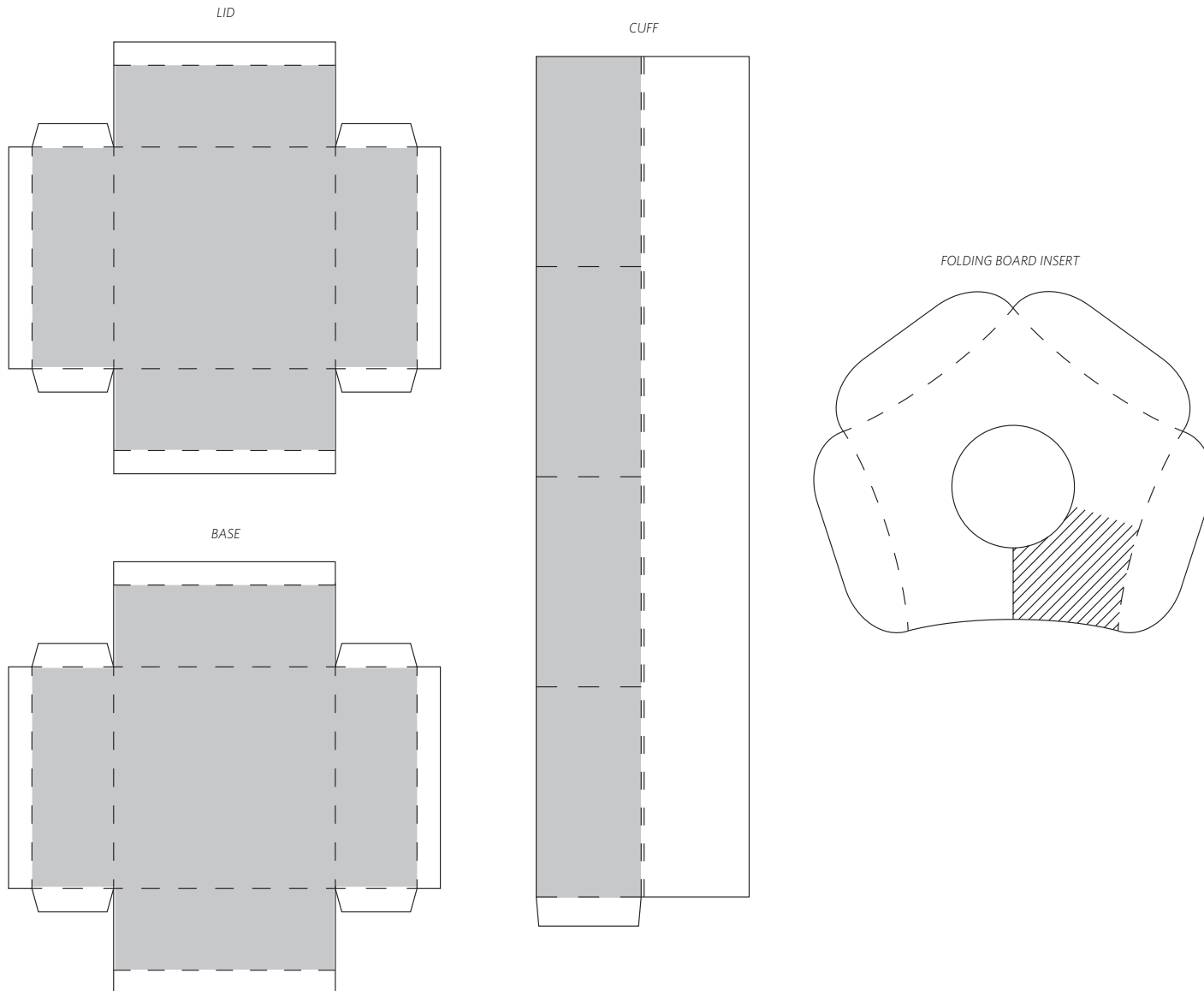

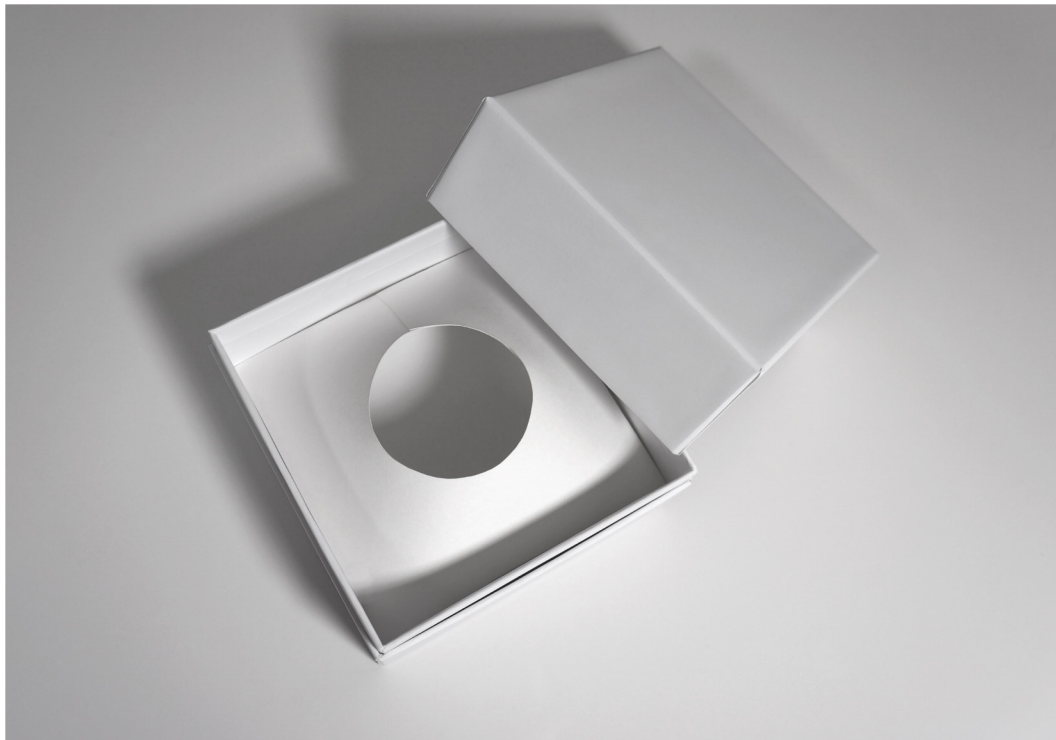

# BOX WITH CHAMFERED INSERT

Not all box inserts need to be flat! The Chamfered Insert edges are faceted to give a lifting, frame effect. The sloped sides draw the eyes toward the center of the insert creating a focal point on the product it holds.

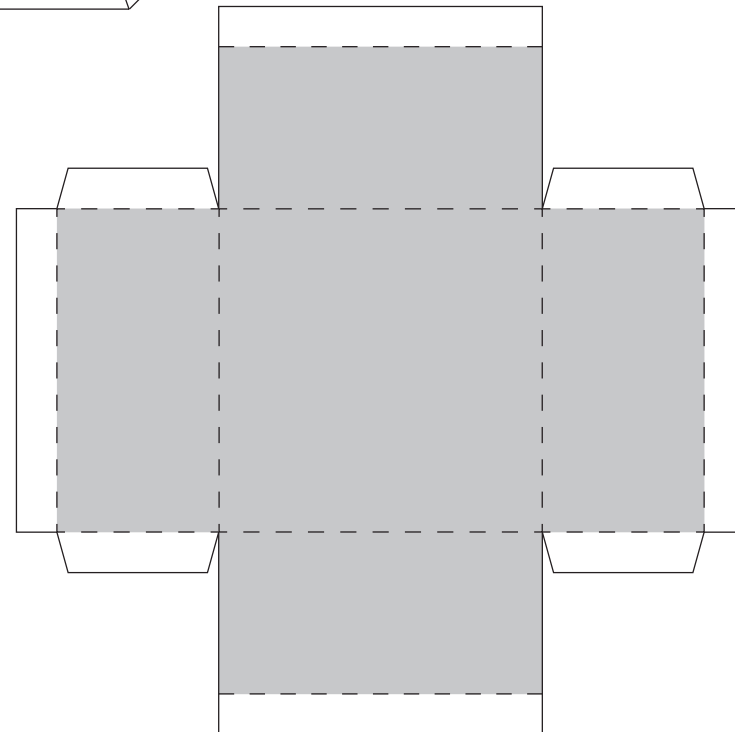
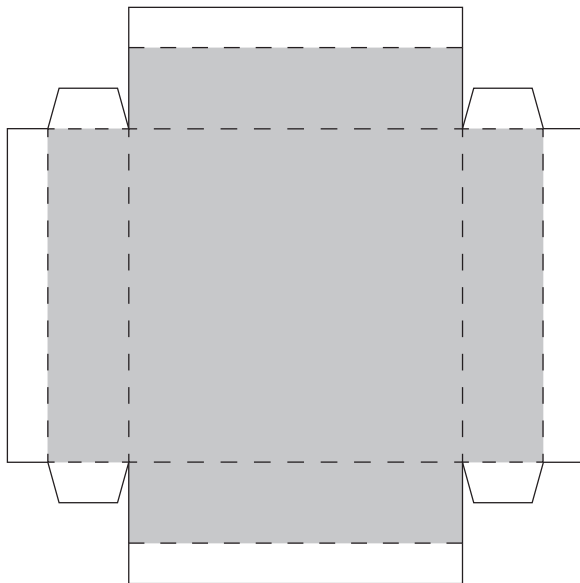
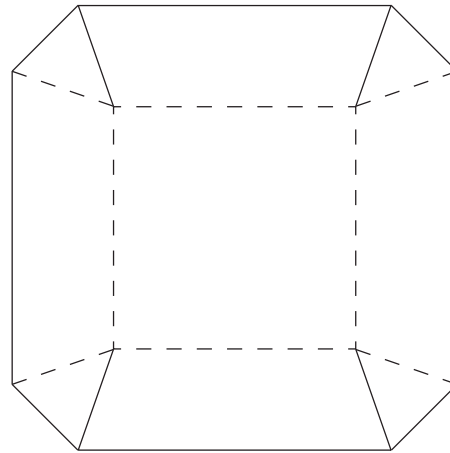



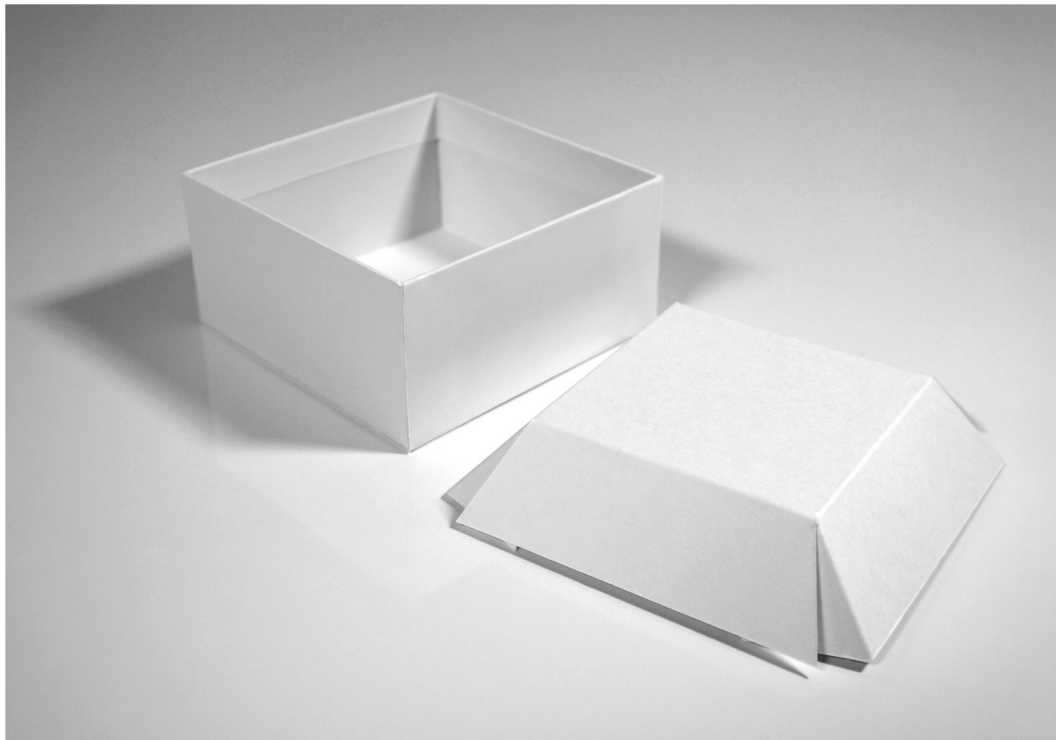

# MUG BOX

The customizable packaging design and insert of the Mug Box secures the handle in place, and provides product visibility. The insert's flat panel allows for art and branding to be applied while the side notch makes it easy to remove.

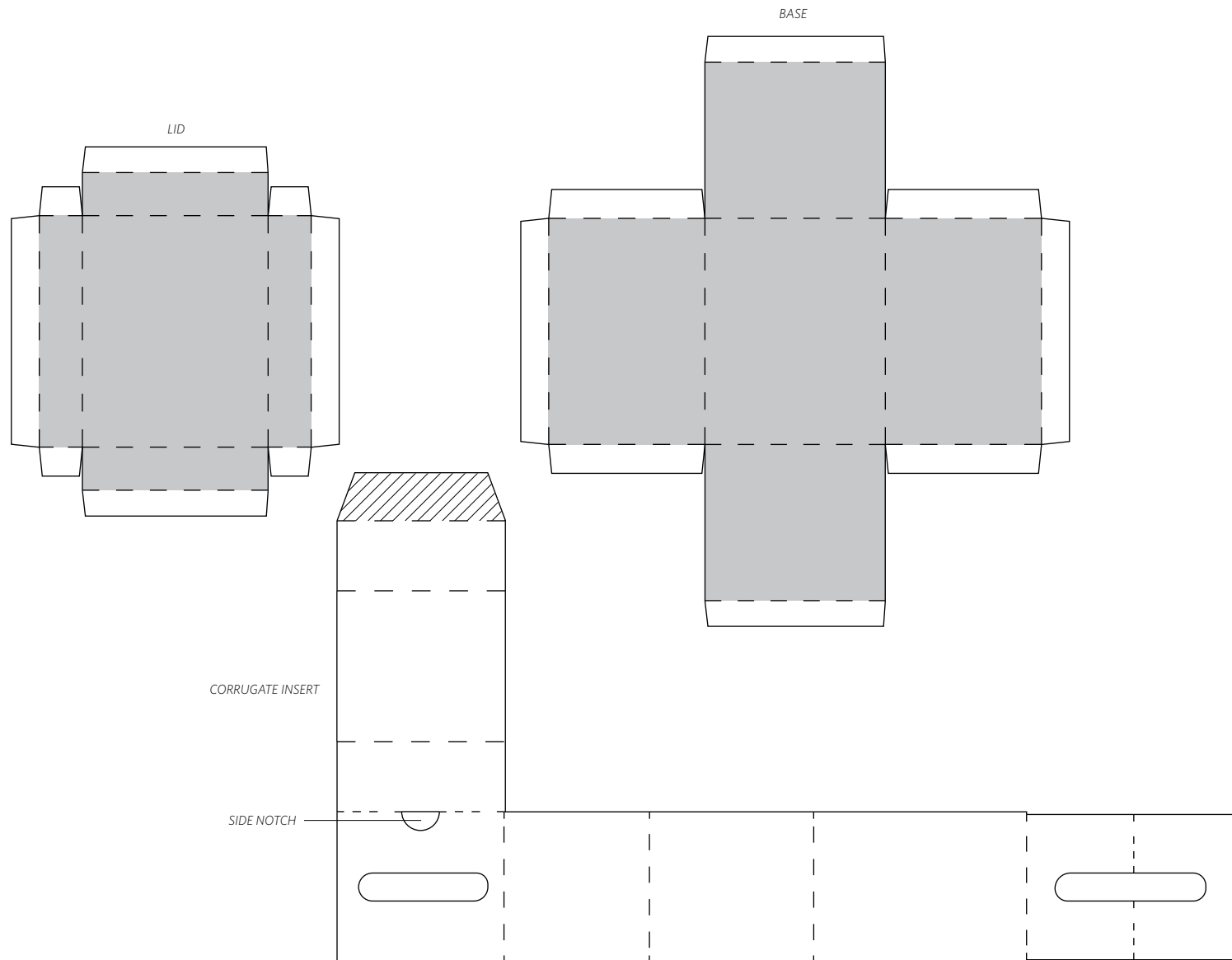







# FOLDING BOXES

Folding boxes are typically used for retail gift packaging or secondary product packaging because of their ease of assembly and fulfillment. Folding boxes are a more cost effective option to rigid boxes because they use card stock that can be directly printed and diecut. Since card stocks come in various weights, densities, and colors, we recommend testing to best determine what works for your application before deciding on final materials. Stocks come in a variety of weights in either coated or uncoated surfaces. We recommend that you always print out the dielines to confirm dimensions, proportions, user experience, and that the structure is what you envisioned prior to applying artwork.

# CURVED CORNER BOX

The faceted edges of the Curved Corner Box provide a soft and elegant feel without veering too far from the standard tuck box, allowing for simple construction and transport.

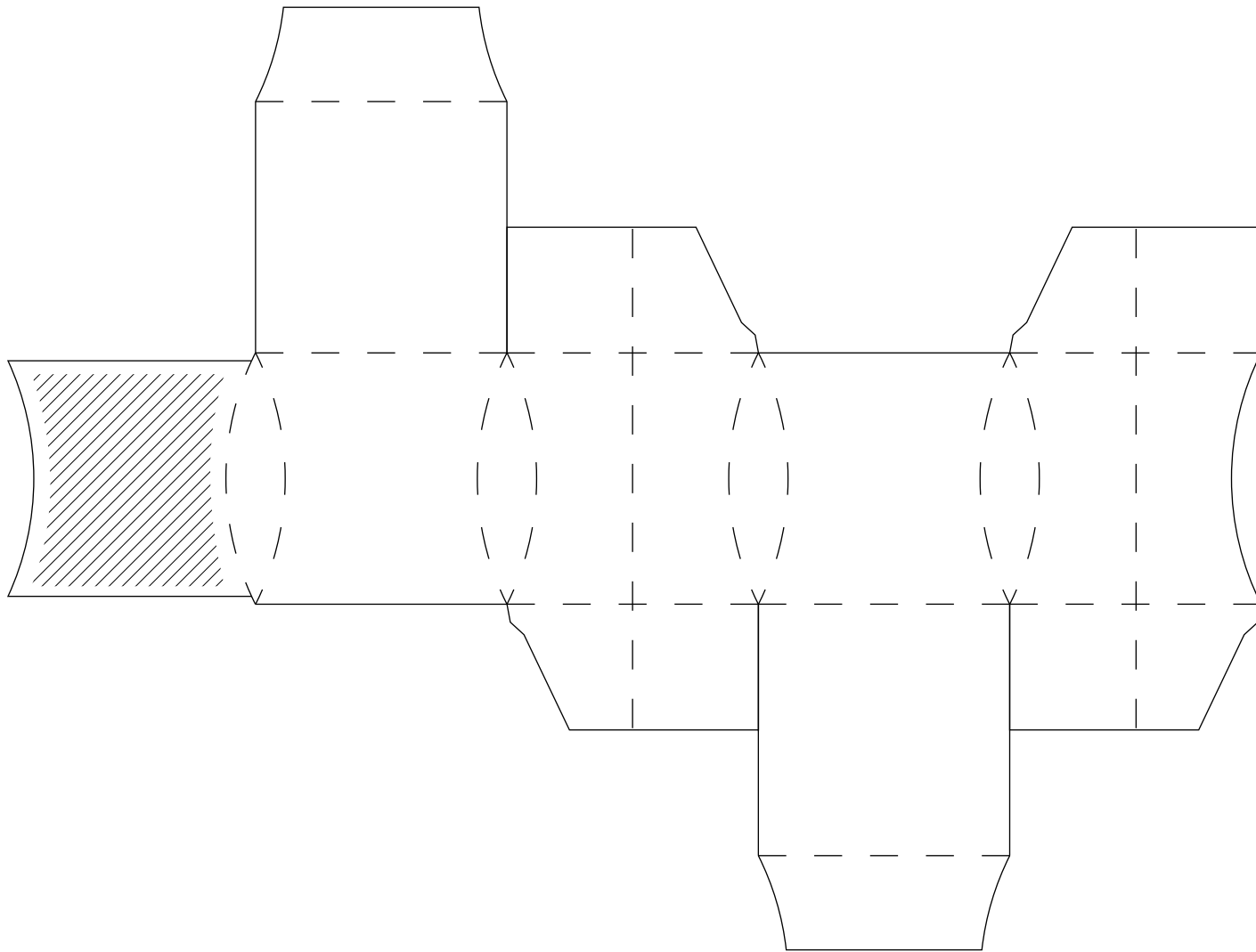

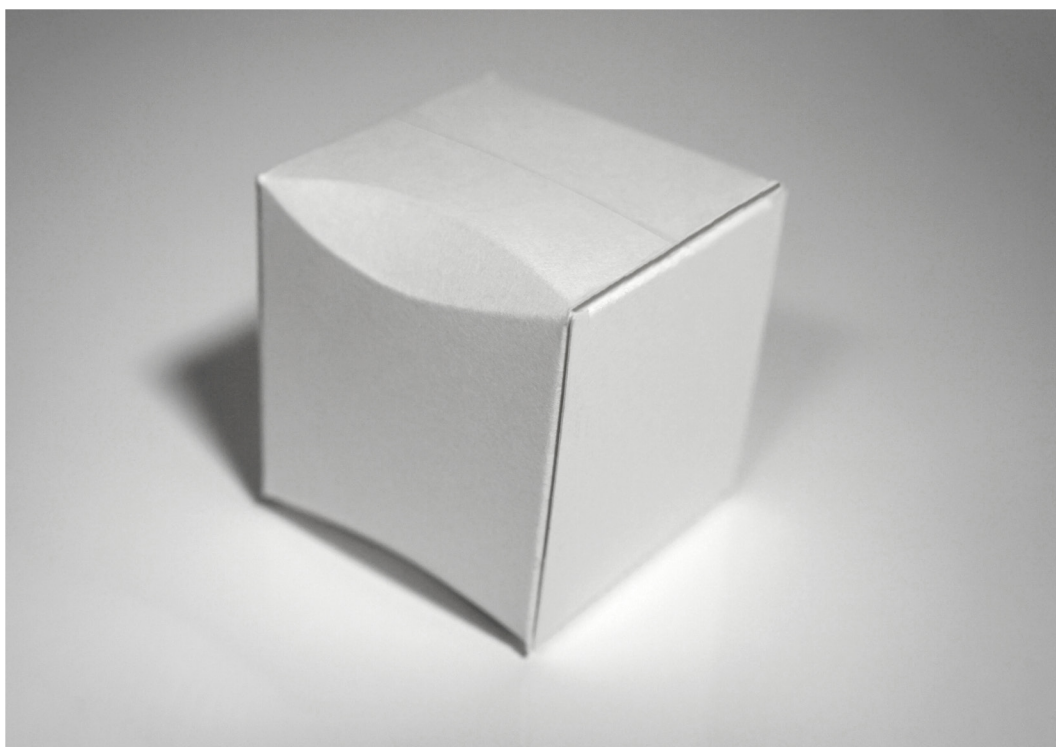
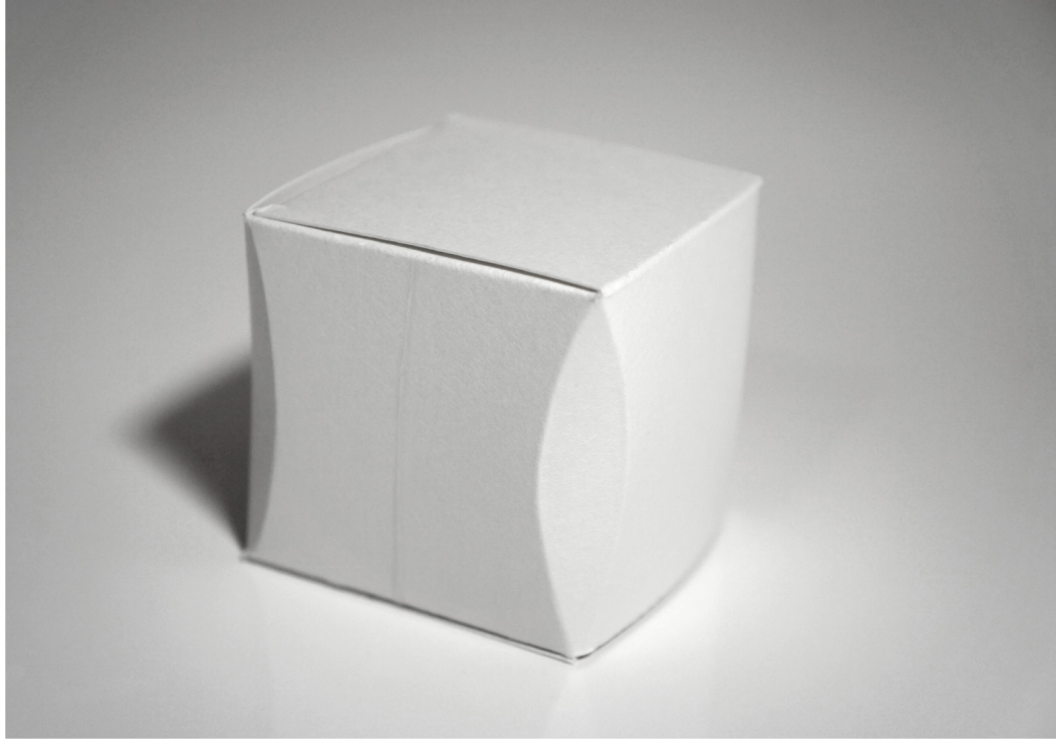
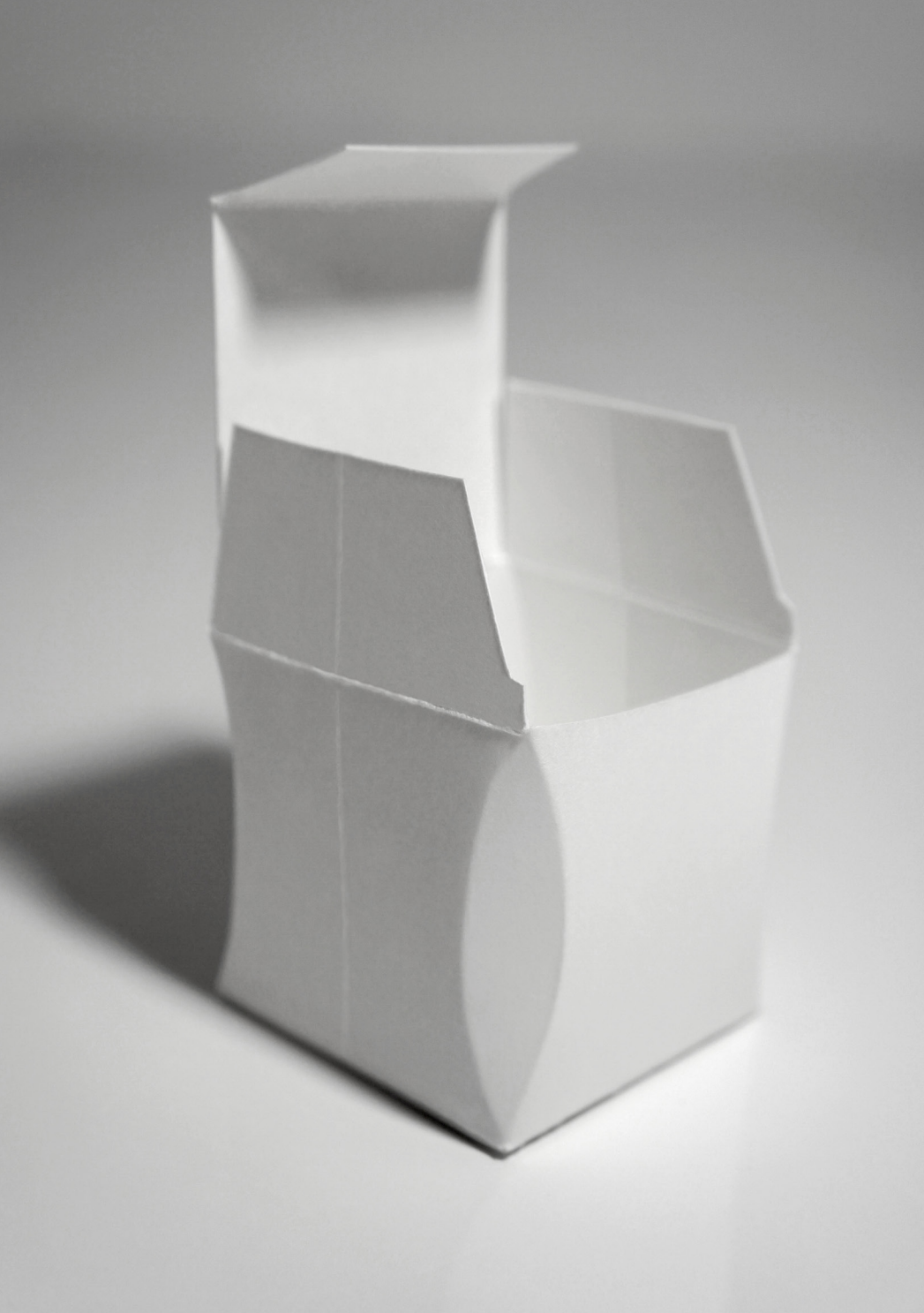

# CURVE BOX

What happens when a pillow box and a tuck-top box get together? The Curve Box features a distinctive silhouette with a simple die line and tuck flap to keep the lid closed.

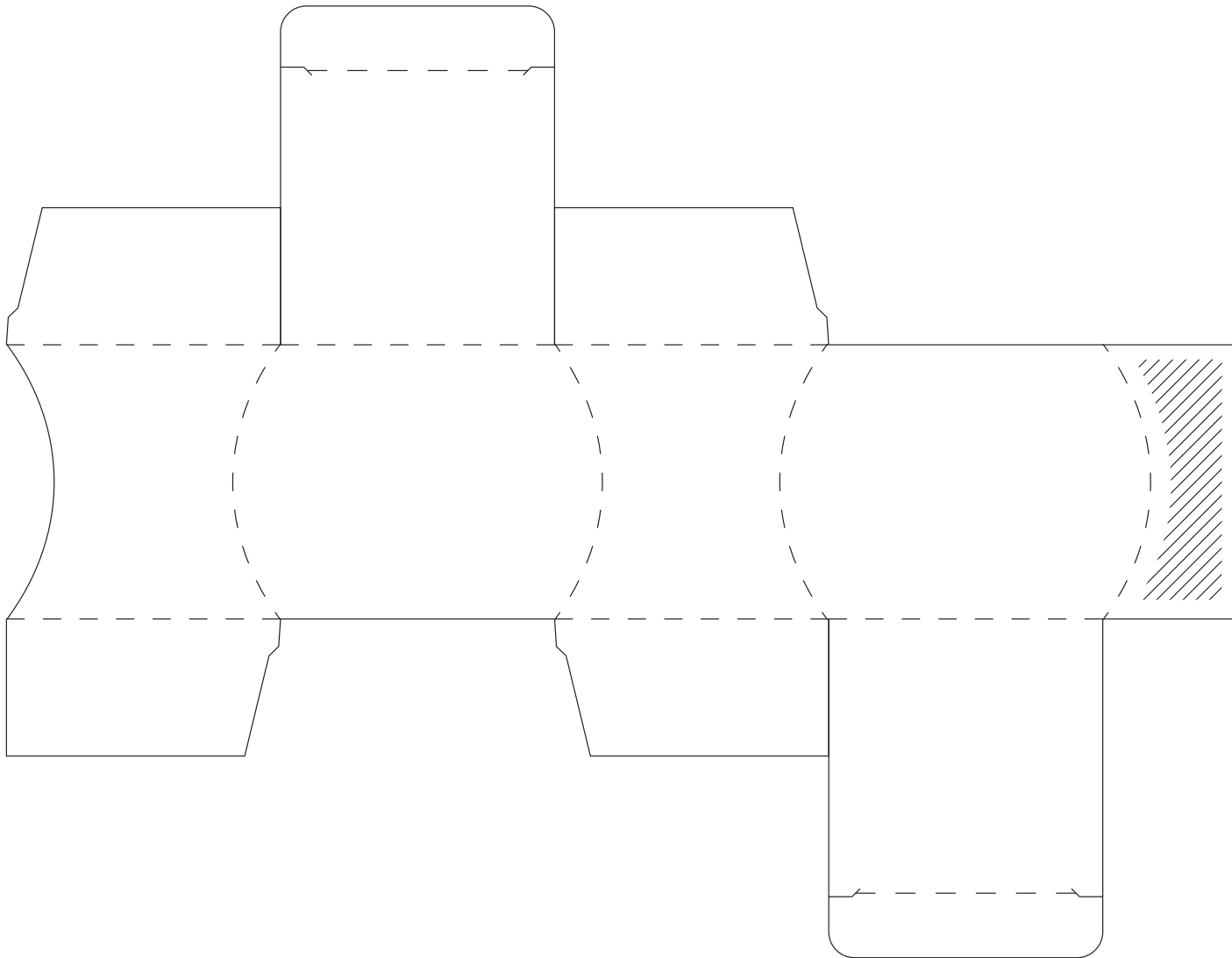



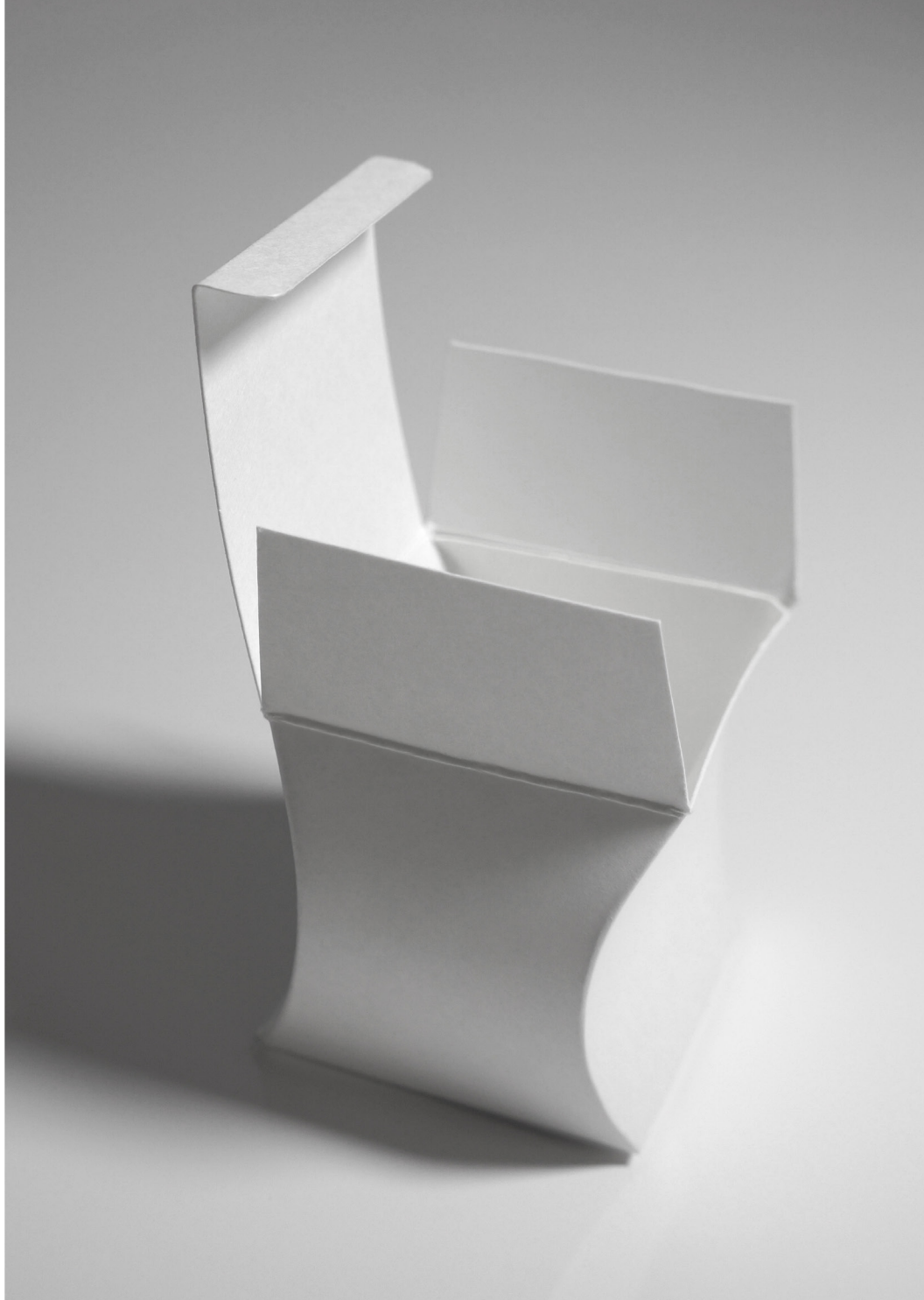
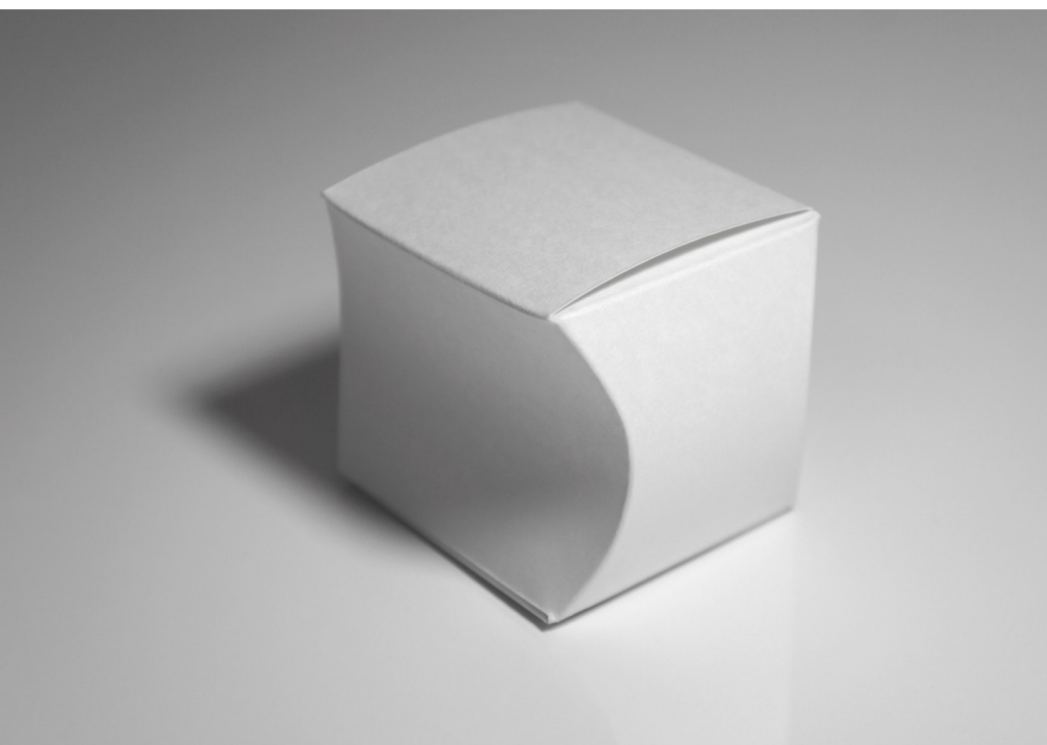

# PURSE BOX

The Purse Box features a triangular silhouette that stands alone, and can be grasped by the top handle. The flap closure fits over and through the handle, tucking into the die cut slot on the other side.

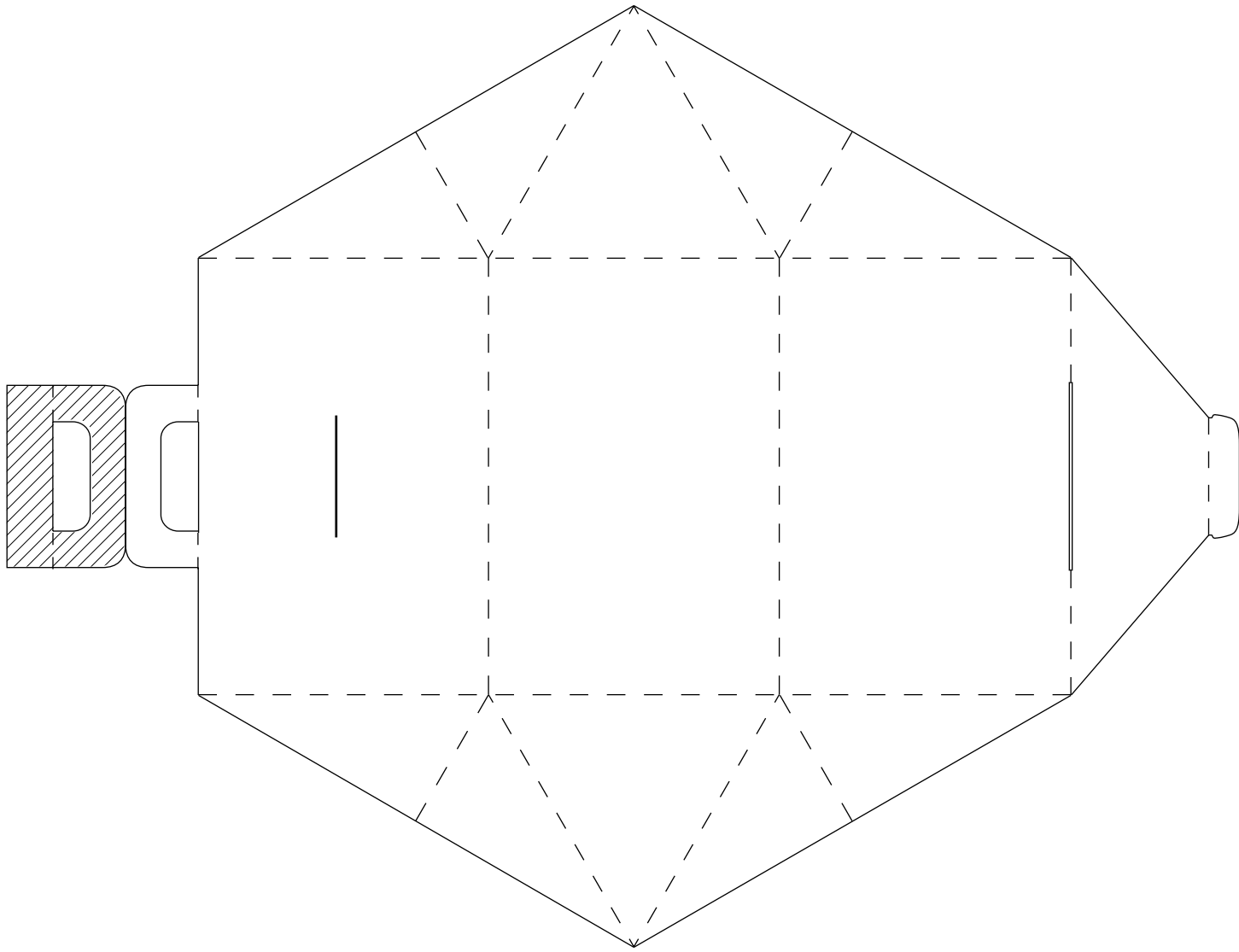

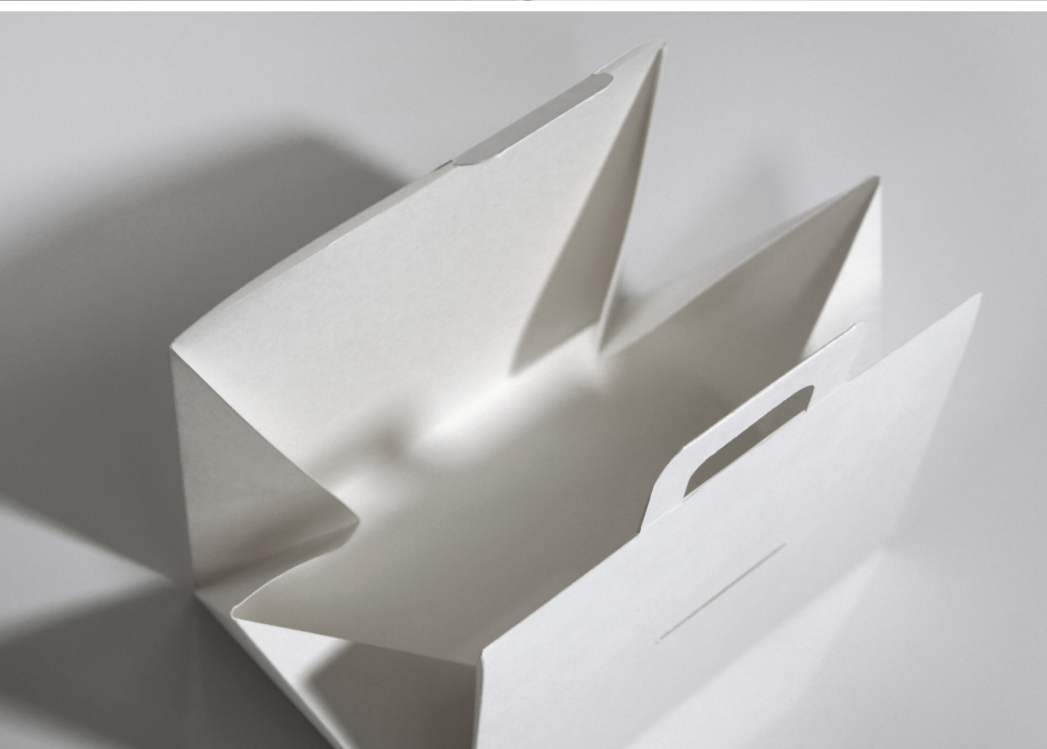

# CAT EAR BOX

The Cat Ear Box features two distinctive hinged doors that when closed, give it cute kitten ears. The middle tray utilizes a simplex packaging design to hold the contents.

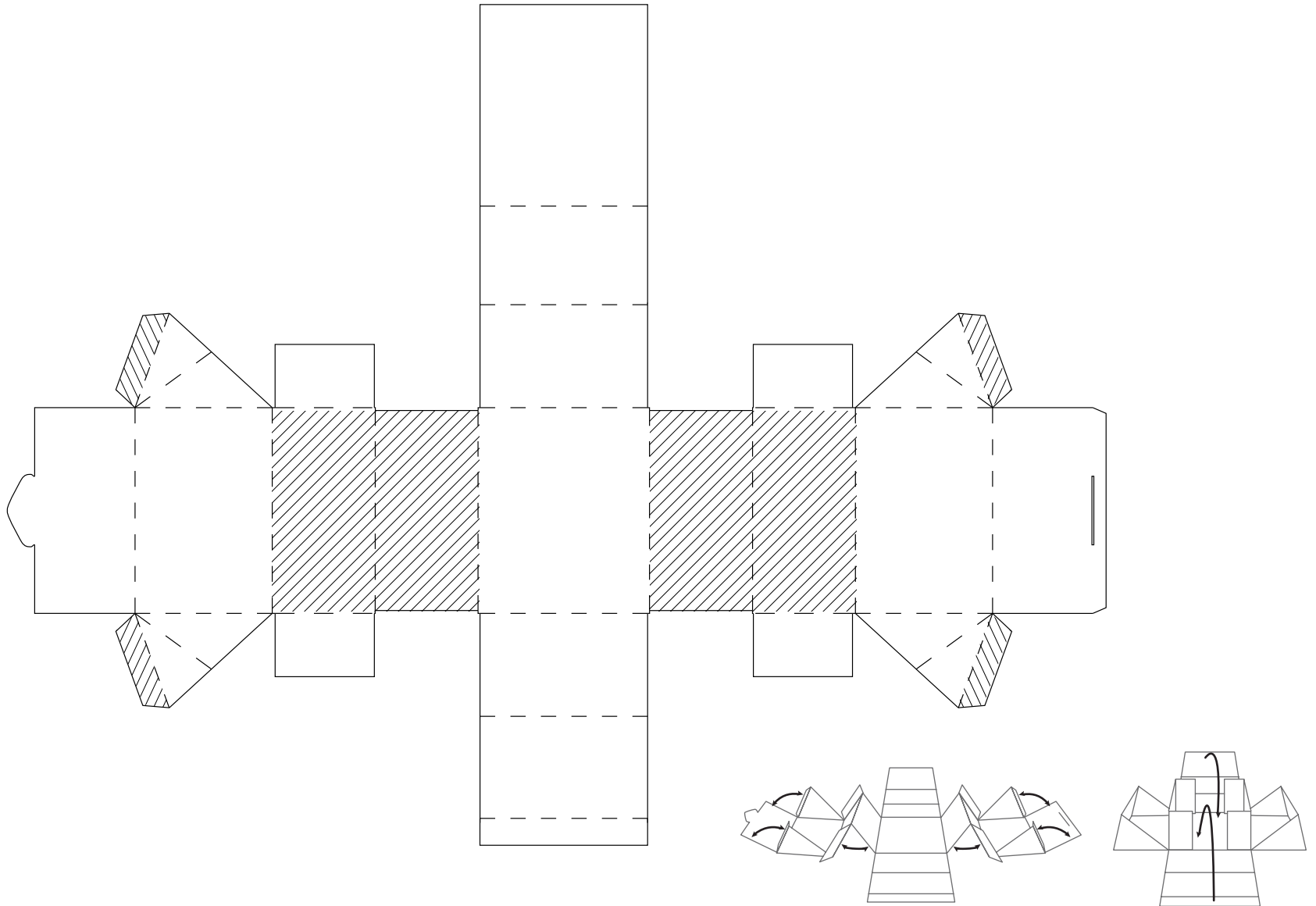

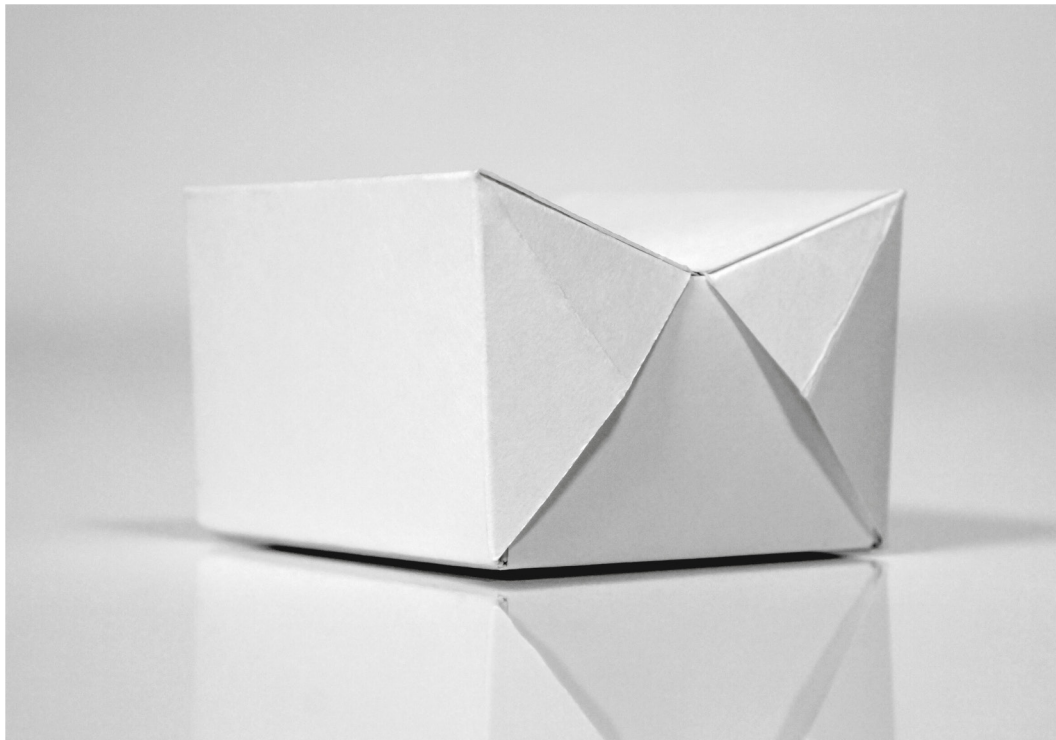
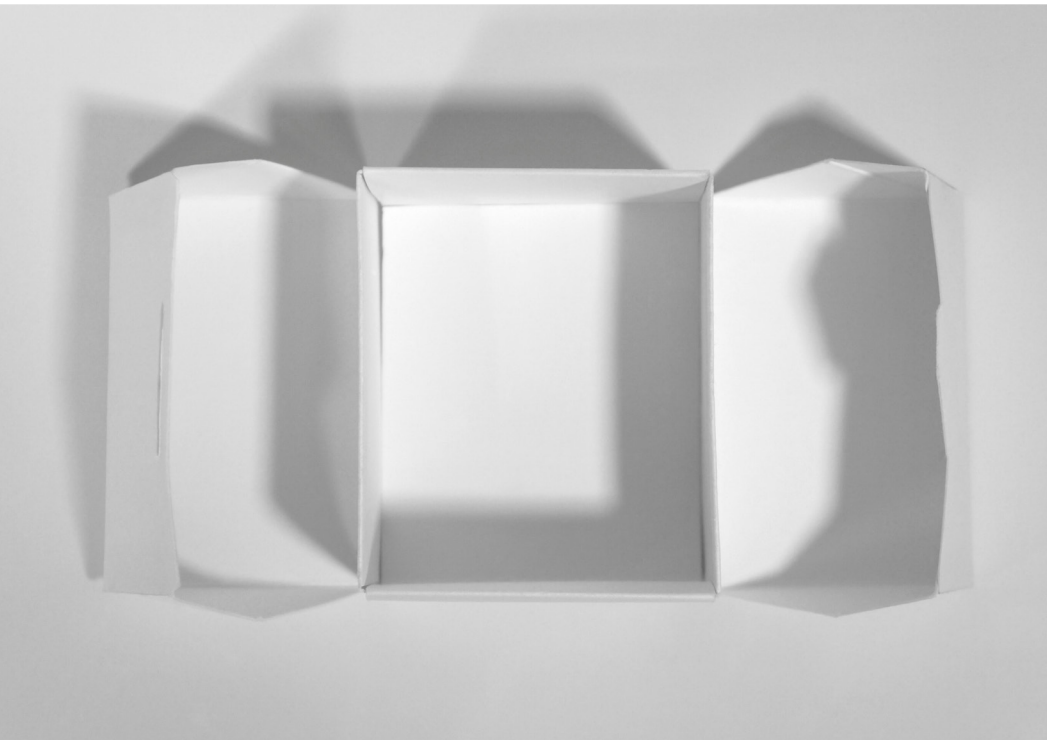
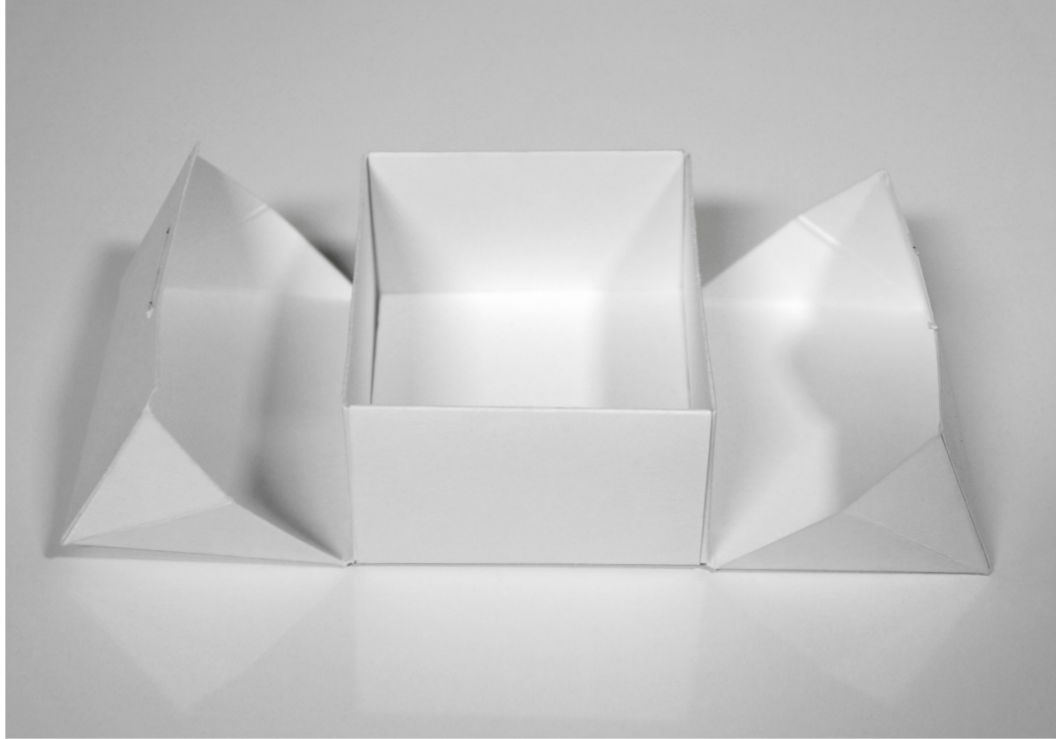
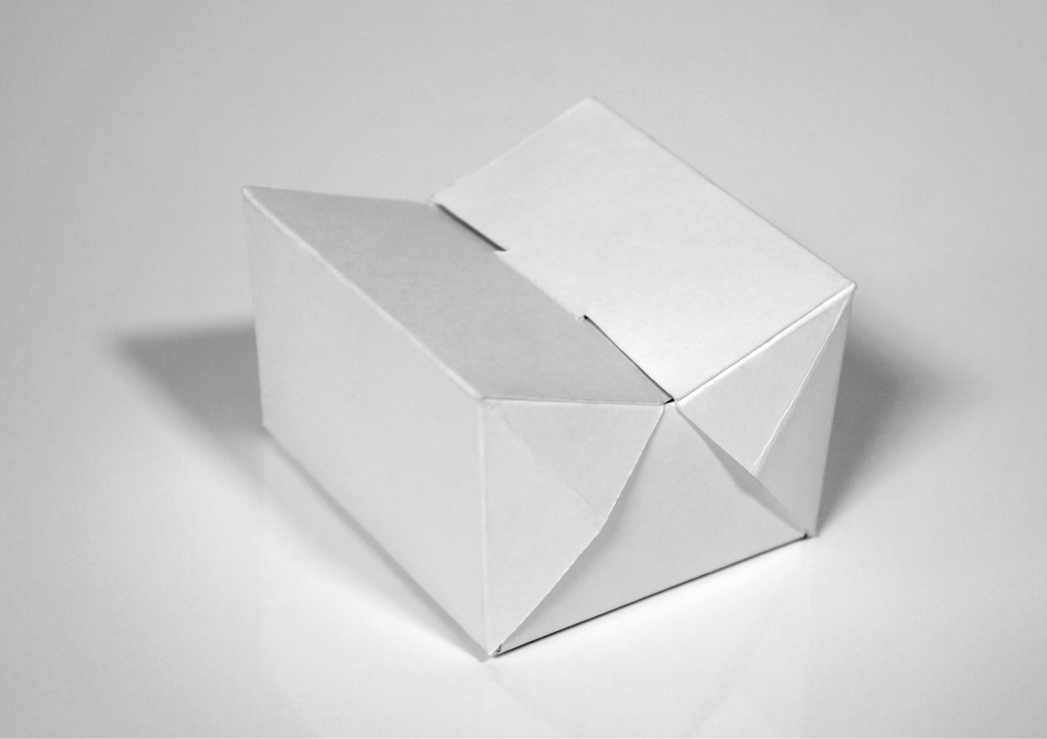

# CAT EAR TUCK BOX

The Cat Ear Tuck Box gets its name from the box's ear-like top. This alternative take on the tuck box has a dip in the middle, giving the packaging design a feline look.

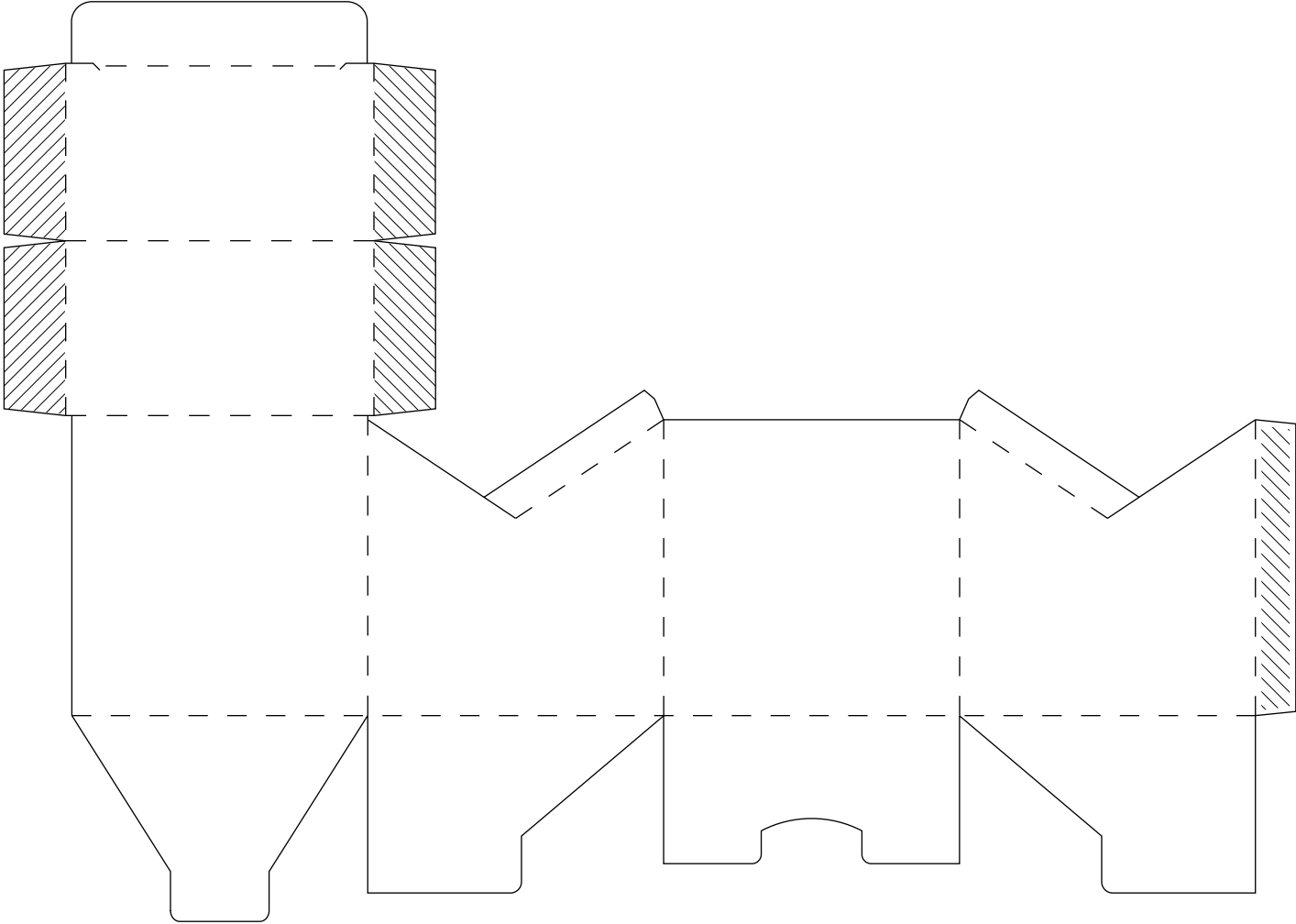

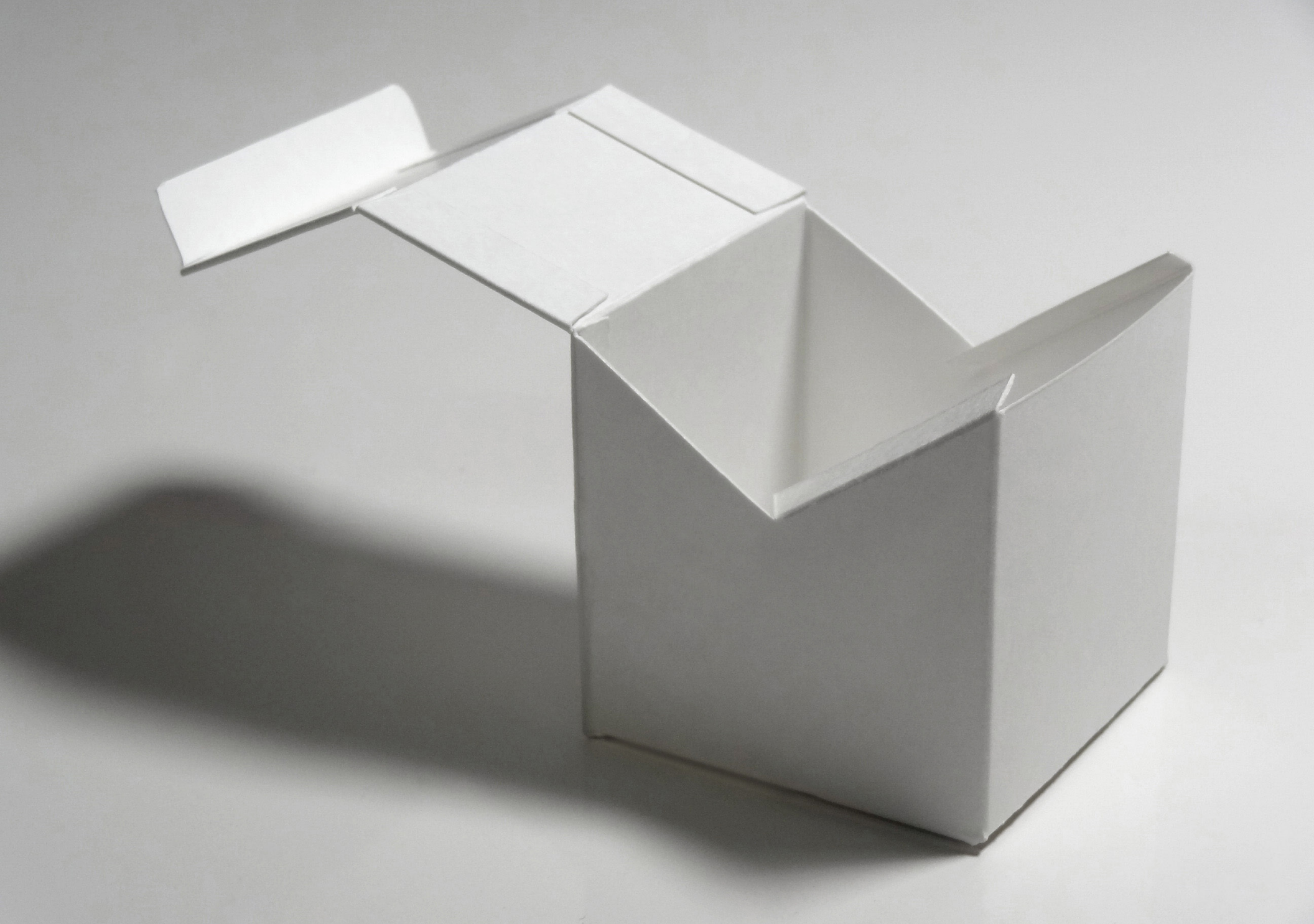

# SIMPLEX HEXAGONAL BOX

This simplex style packaging design applies a glue-less packaging dieline to a six-sided construction creating a simple alternative to traditional retail gift boxes.

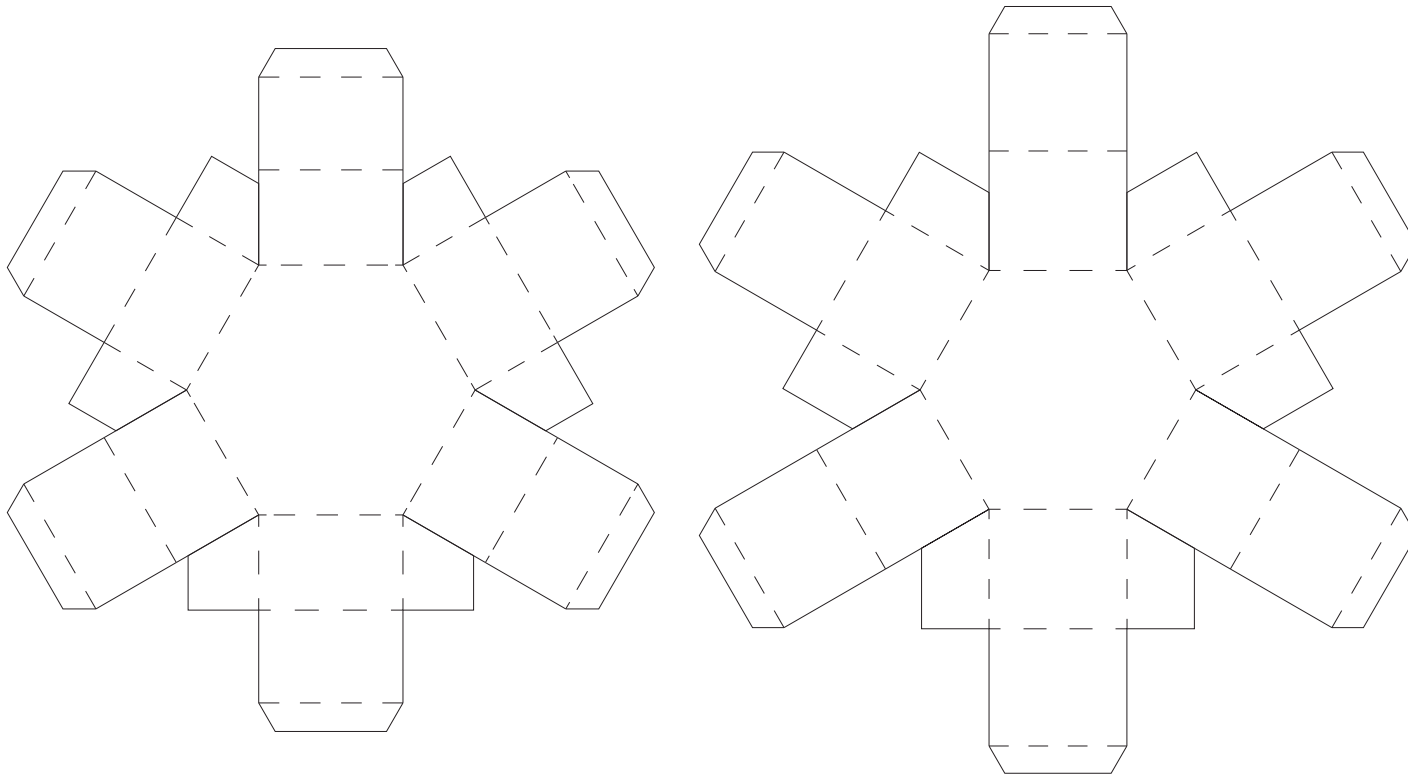



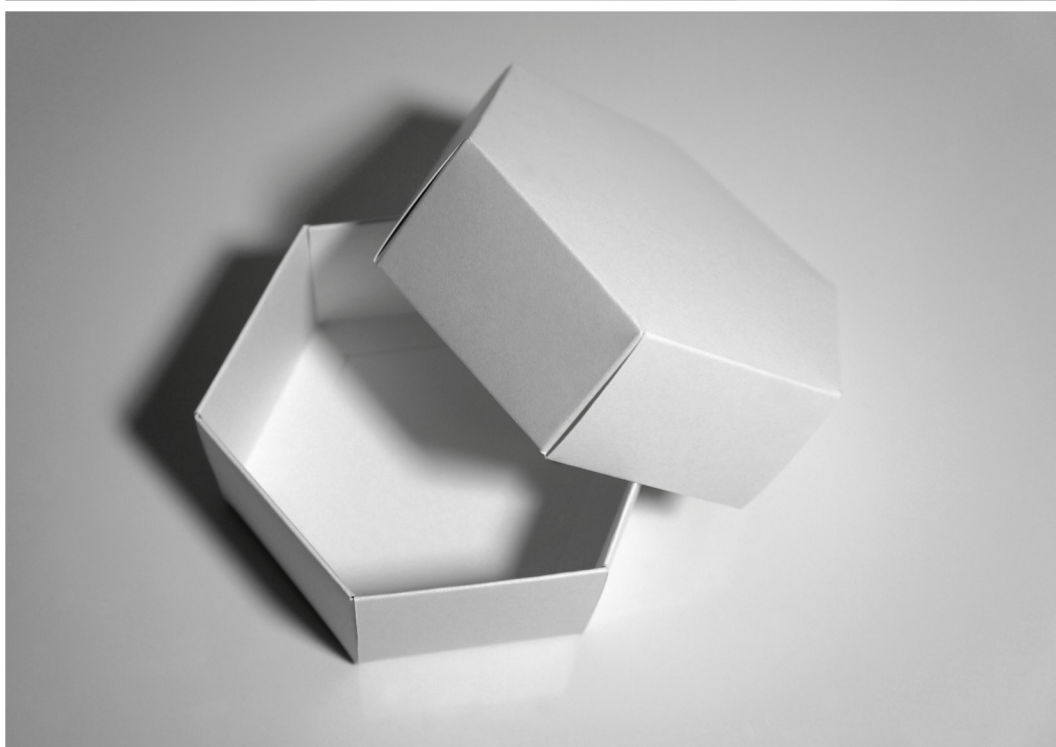
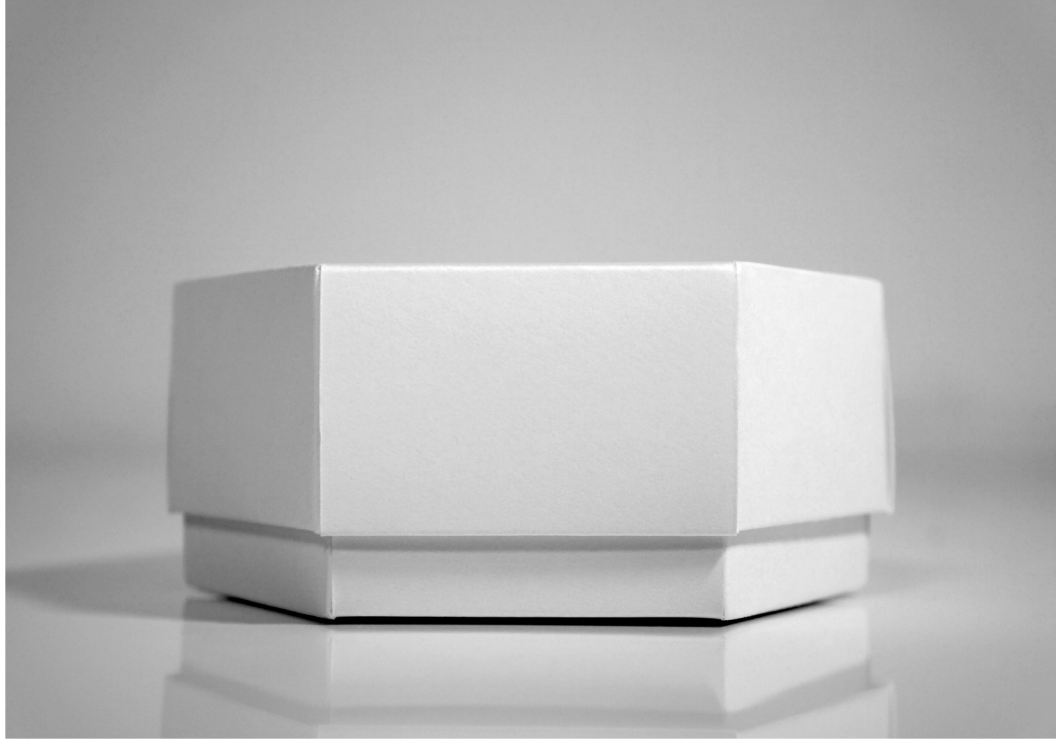
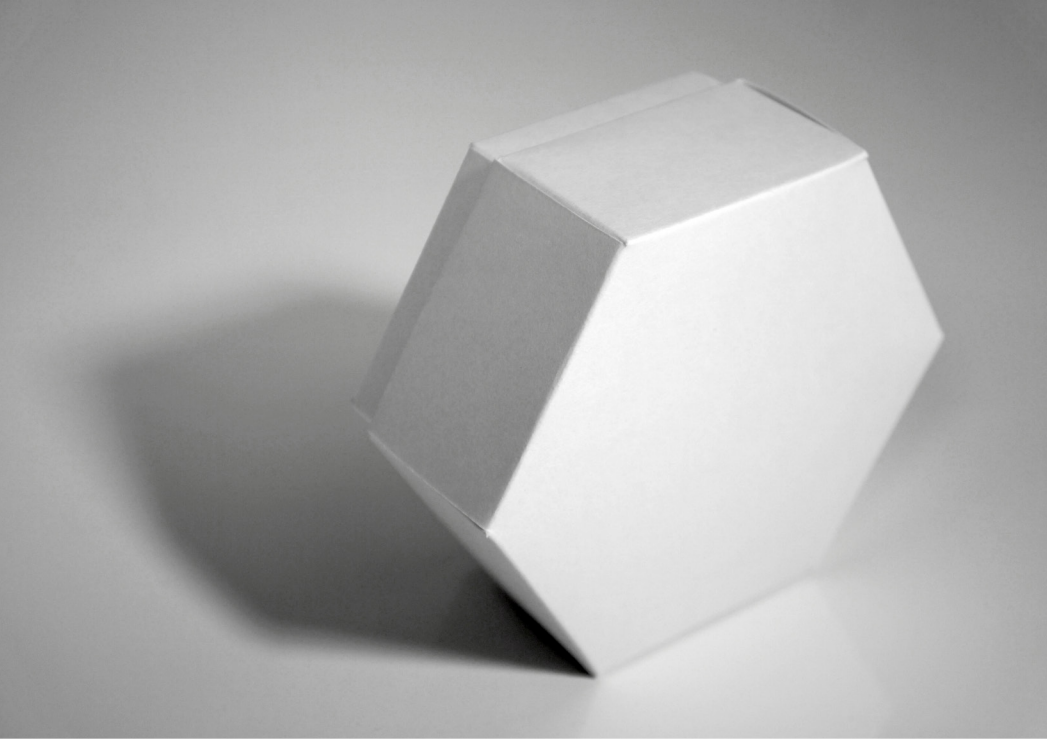

# BLOOMING BOX

The Blooming Box springs open like a flower, creating a dramatic platform to showcase your product as it's slowly unveiled by the packaging design's opening motion.

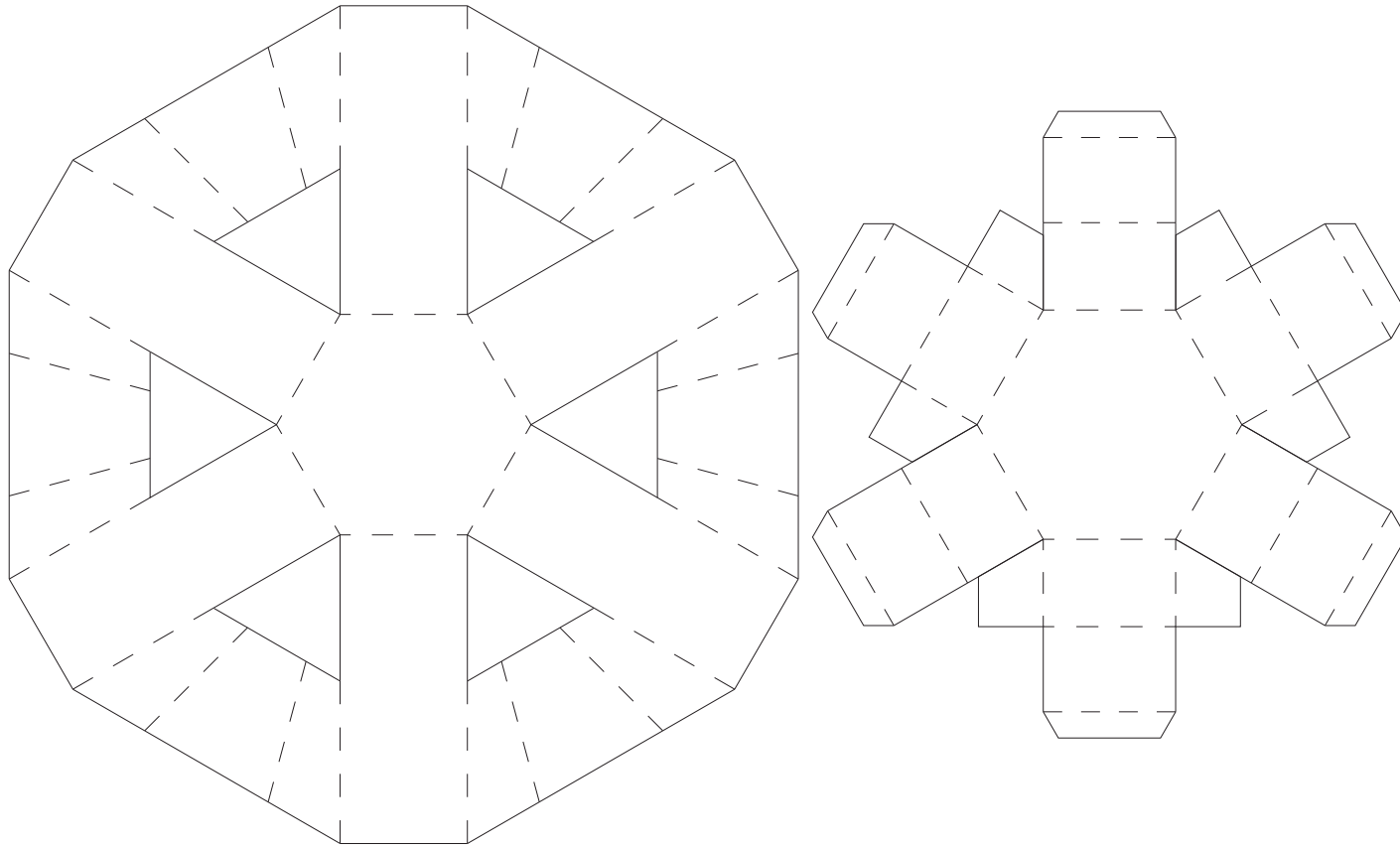

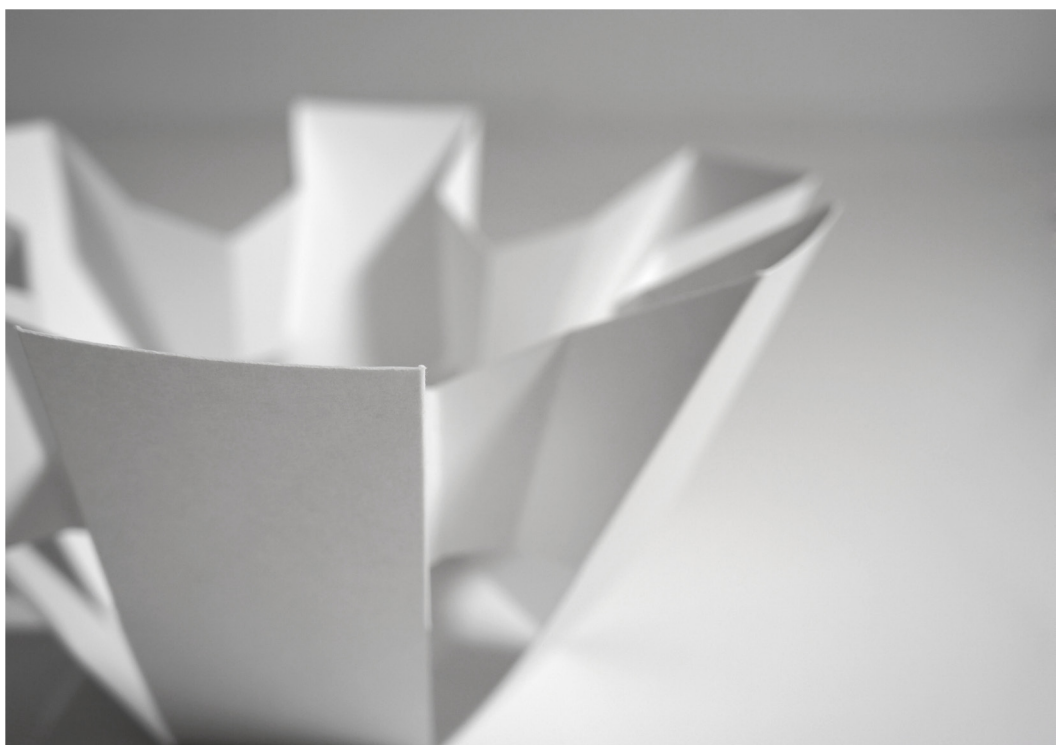
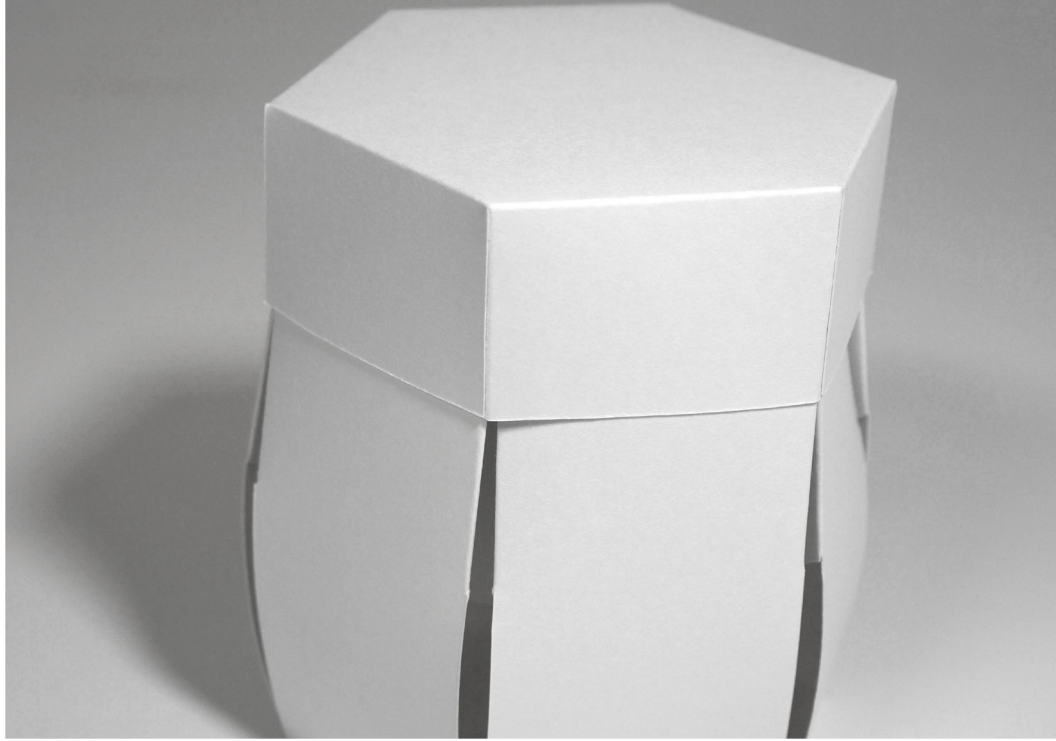

# 3-POCKET CONE

The 3-Pocket Cone packaging design features three pockets that can each hold a unique product, making it ideal for products that come in sets or multiple parts, providing a unique consumer unboxing experience.

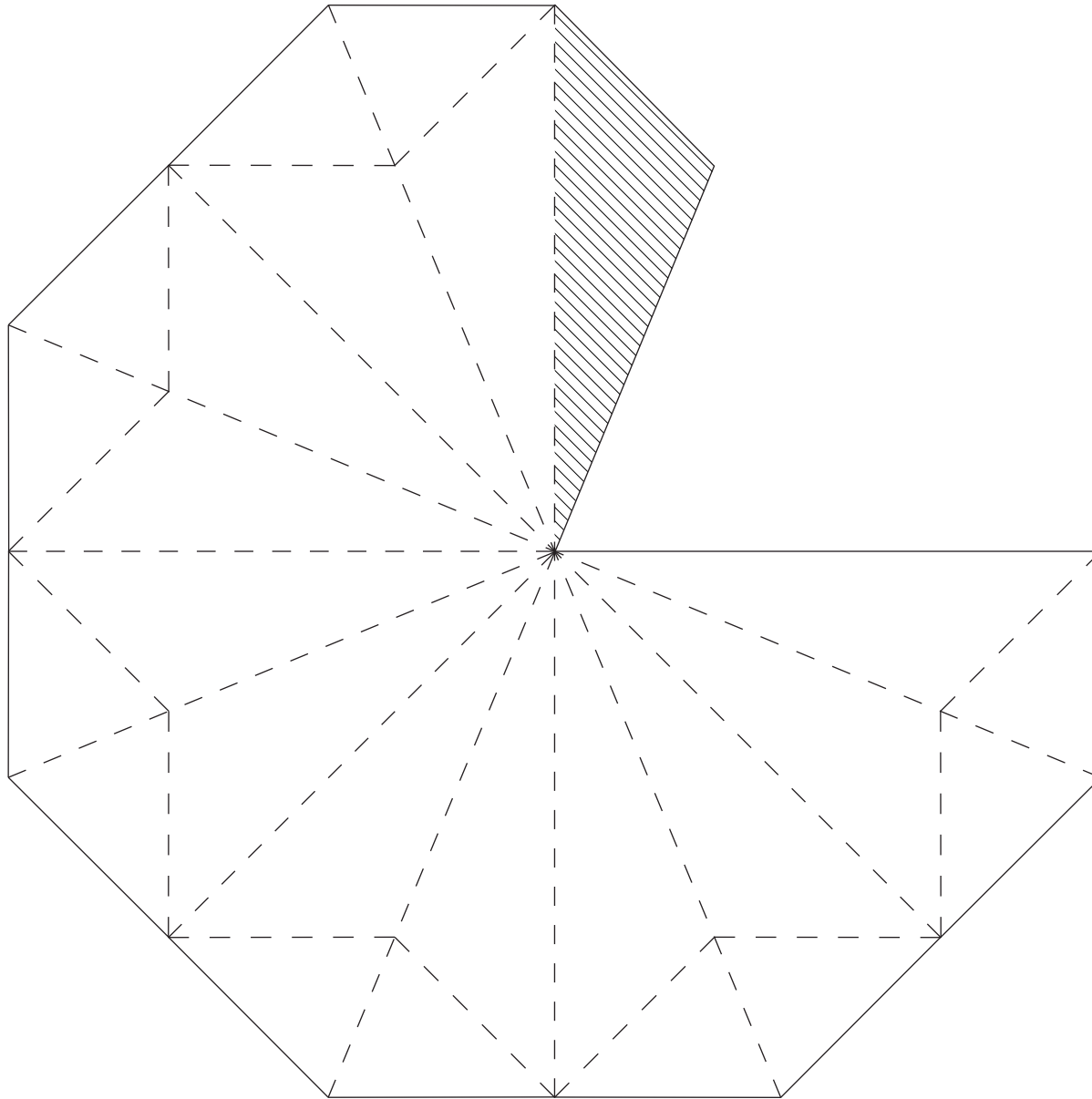

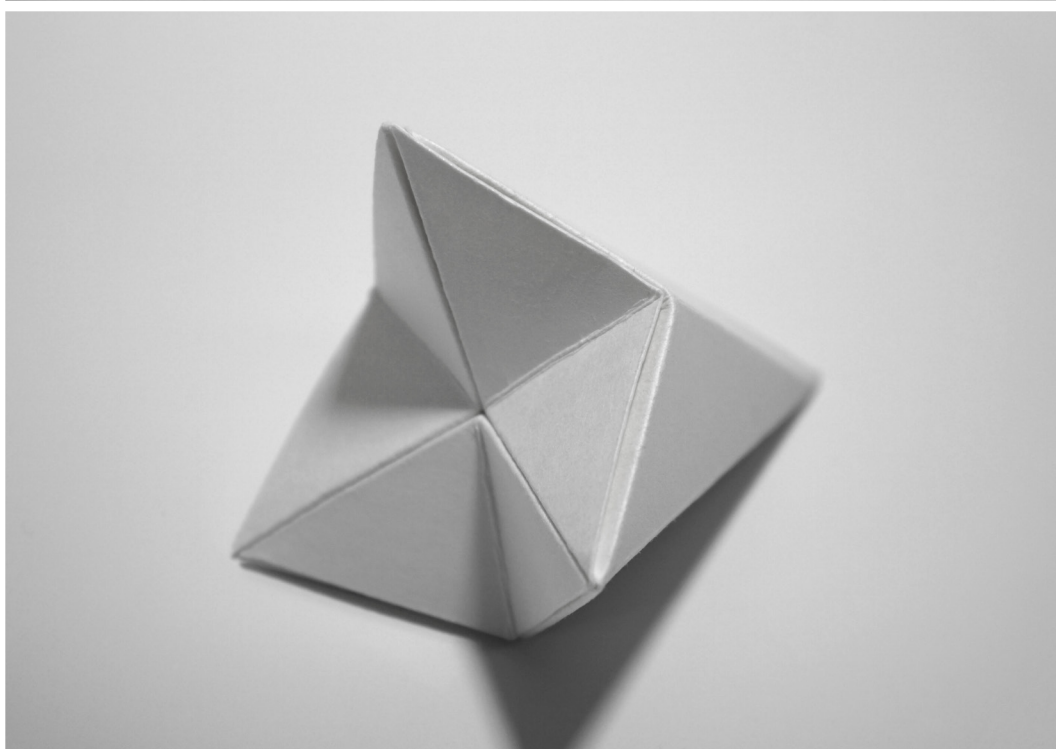
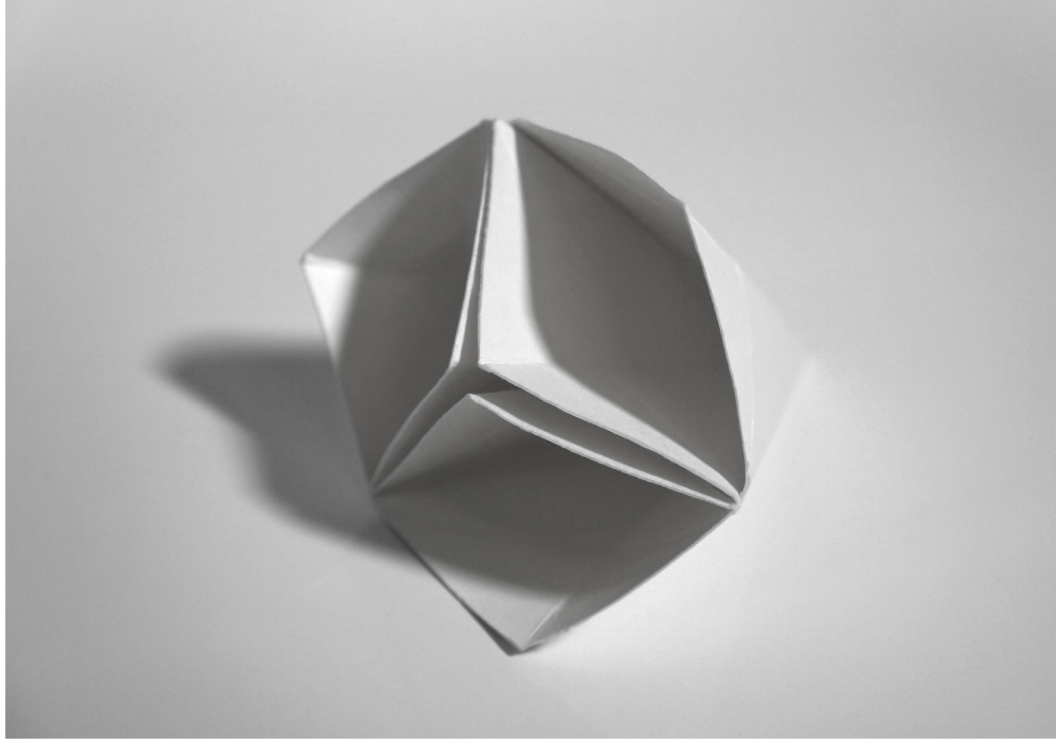
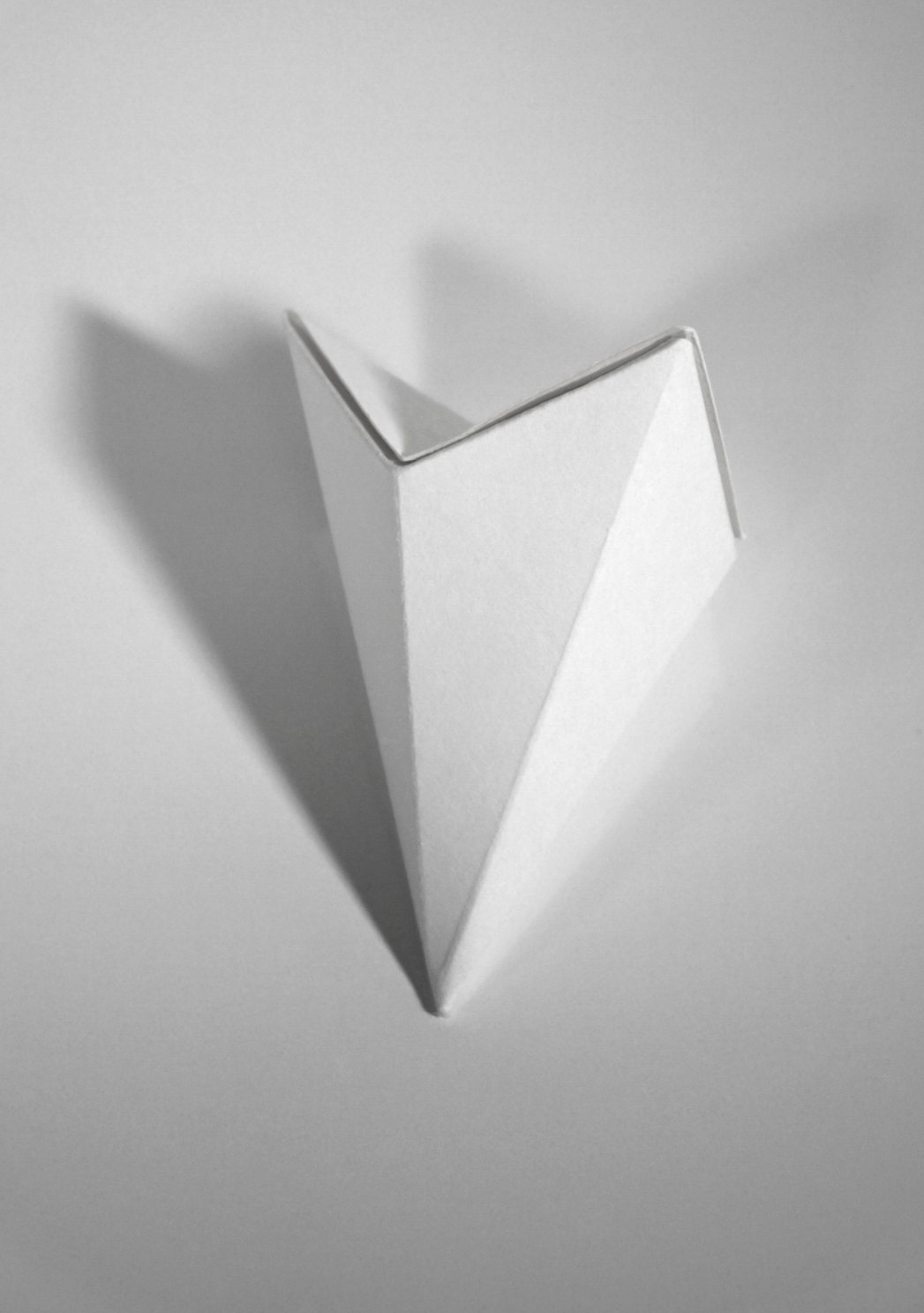

# TRIANGLE FRAME BOX

This unique packaging design features a strong triangular form and large windows that perfectly frame the contents.

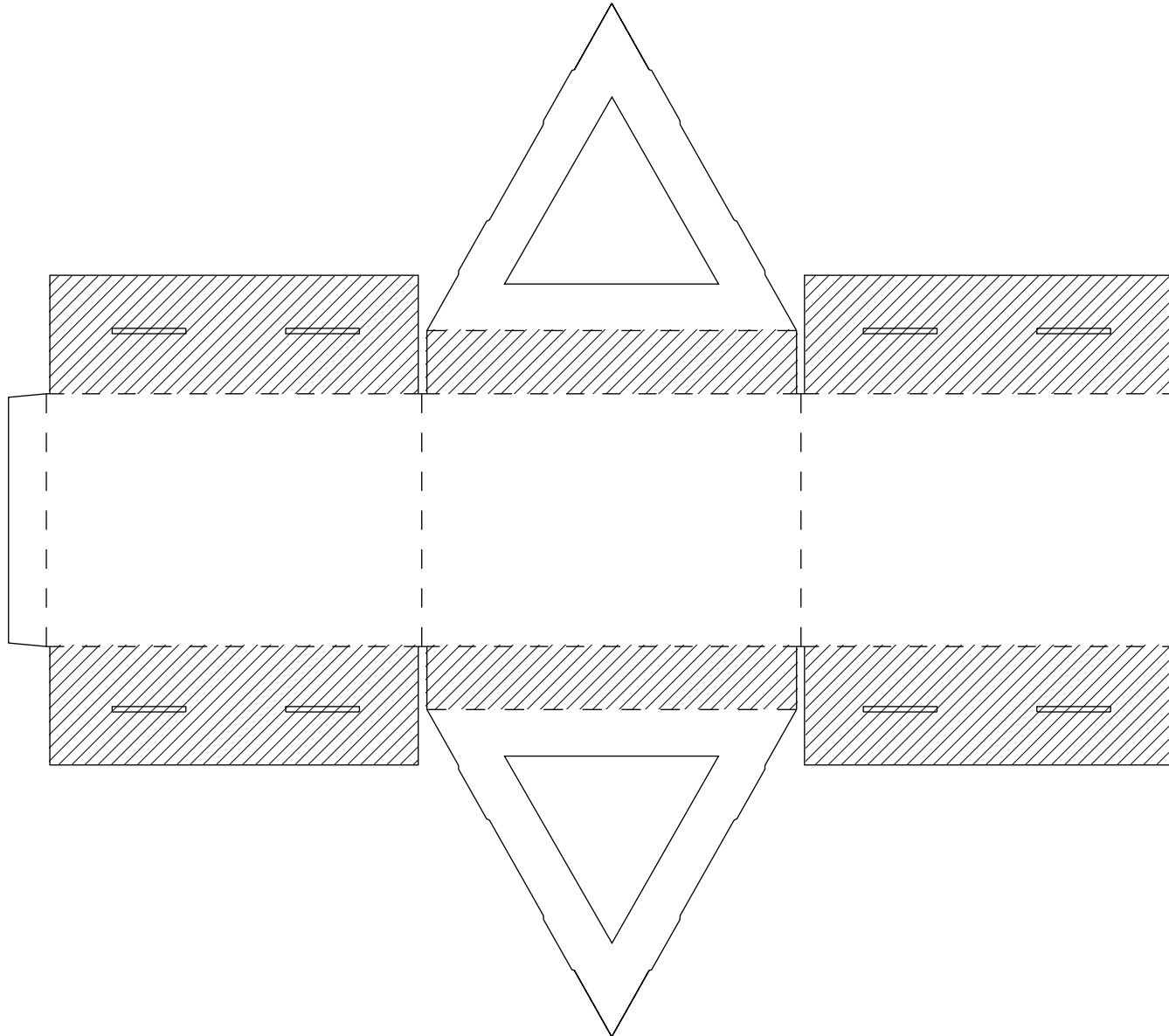

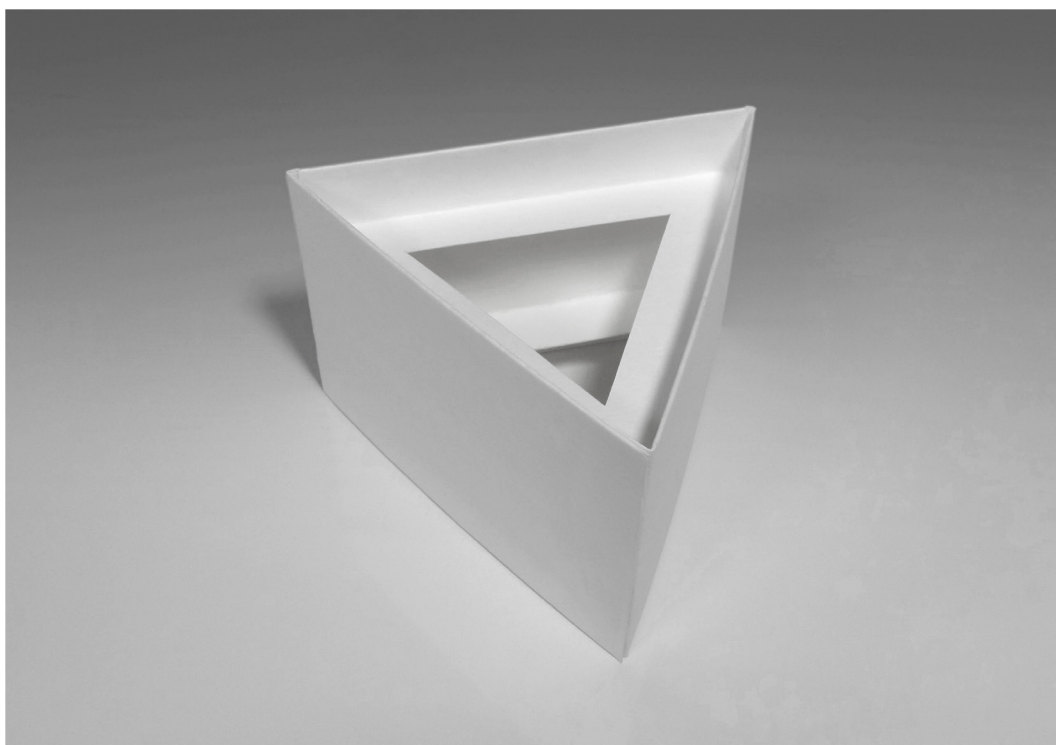
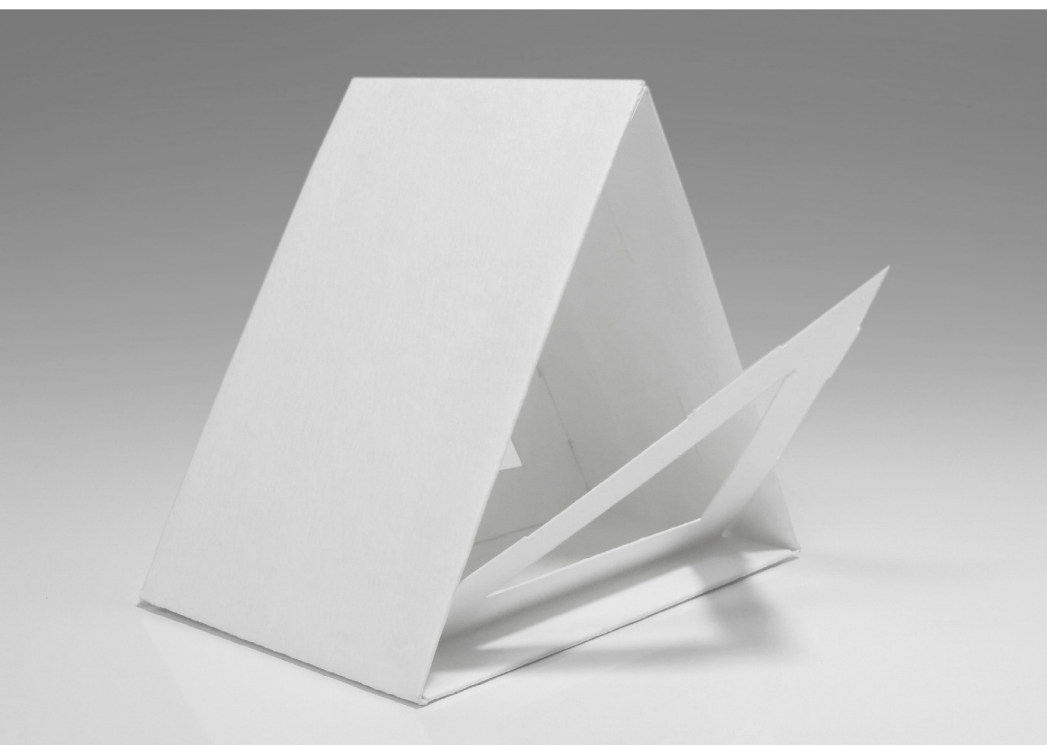

# ZIG ZAG BOX

The Zig Zag Box reflects the light, and cast shadows to create a dynamic shelf presence. The packaging design can be lengthened or shortened to suit the specific needs of the contents.

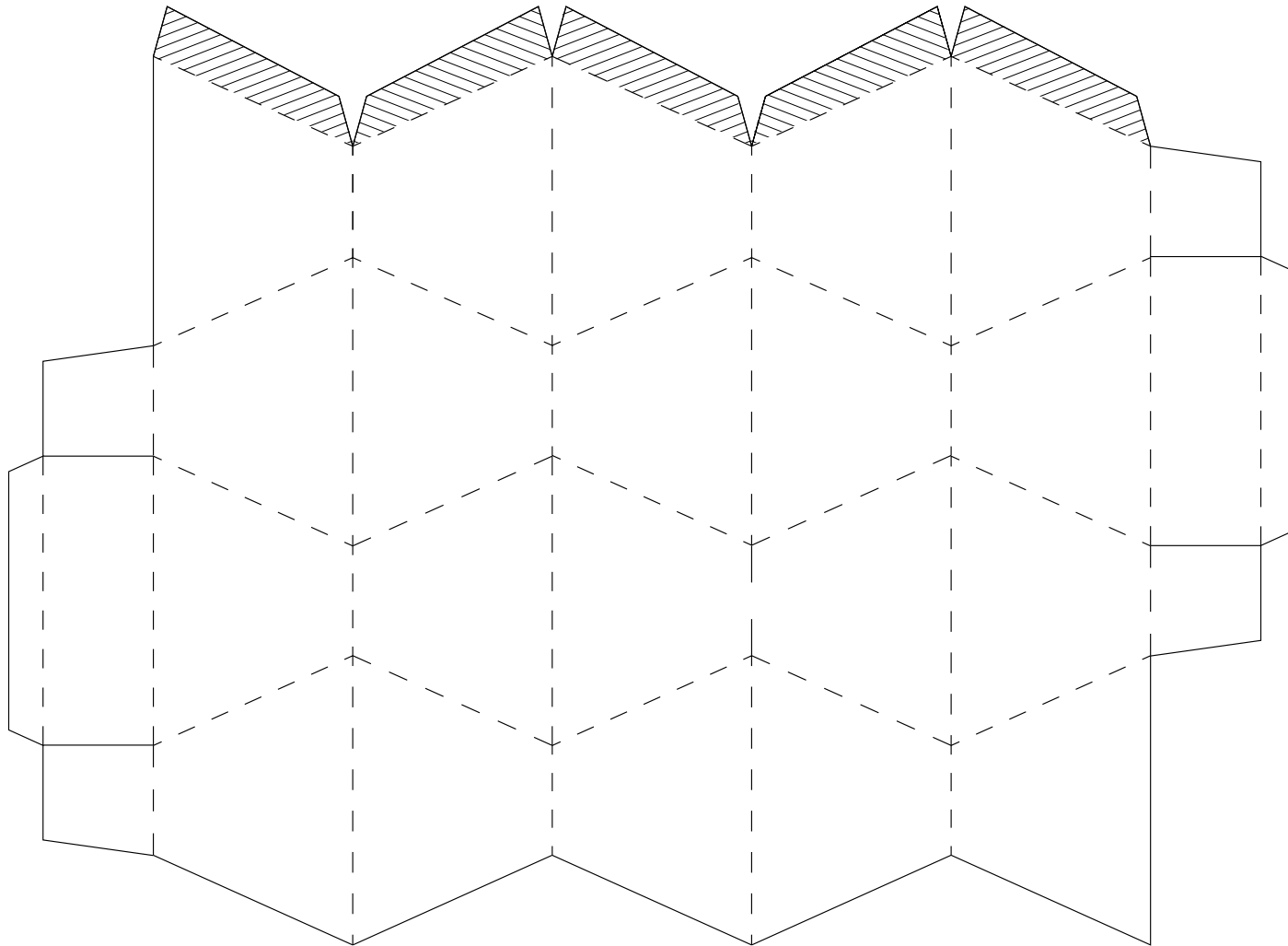



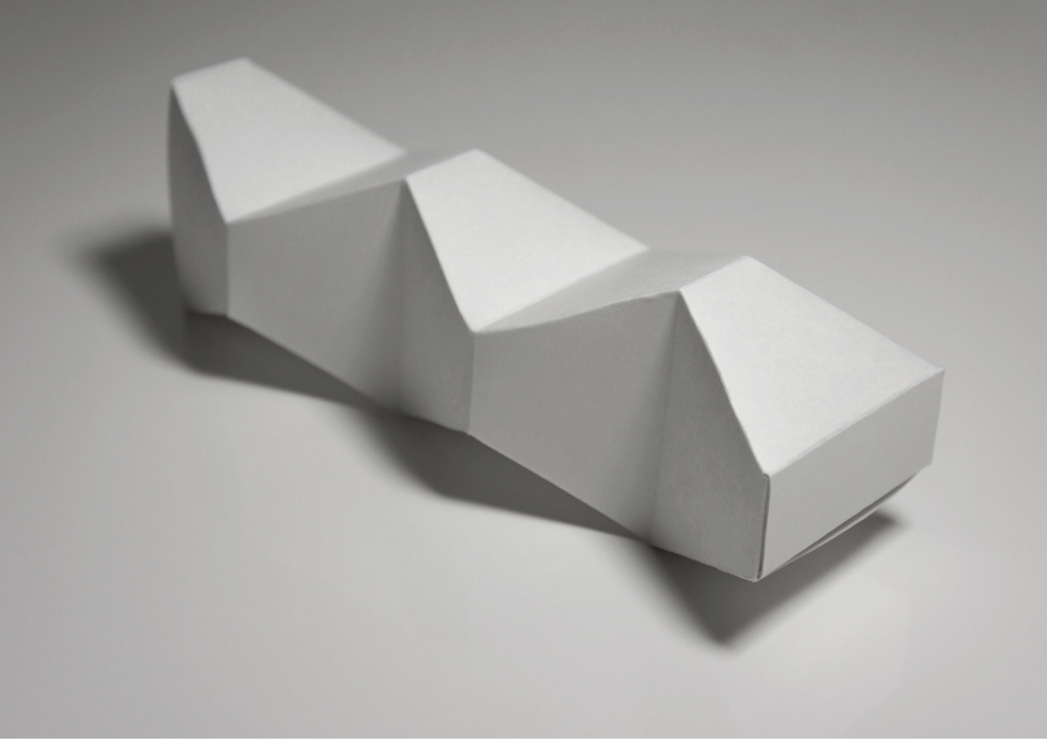

# DOUBLE POCKET ORNAMENT BOX

The Double Pocket Ornament Box contains two pockets for triple the surprise! The first surprise when they realize it's not just an ornament, and two other surprises when they open each pocket.

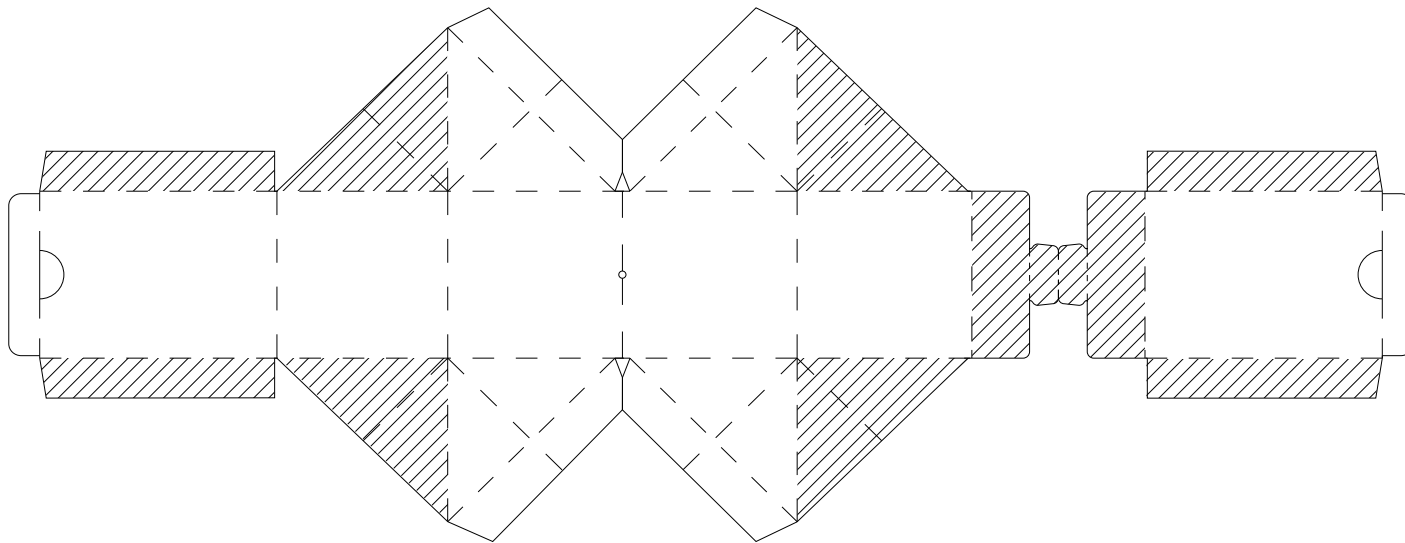

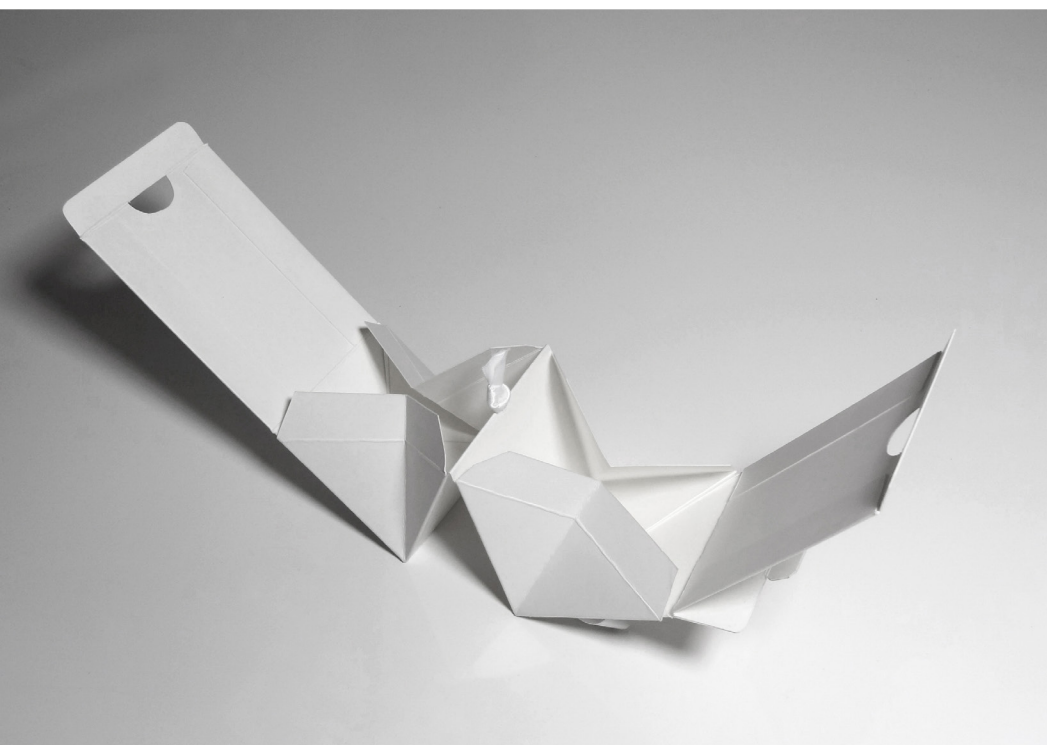
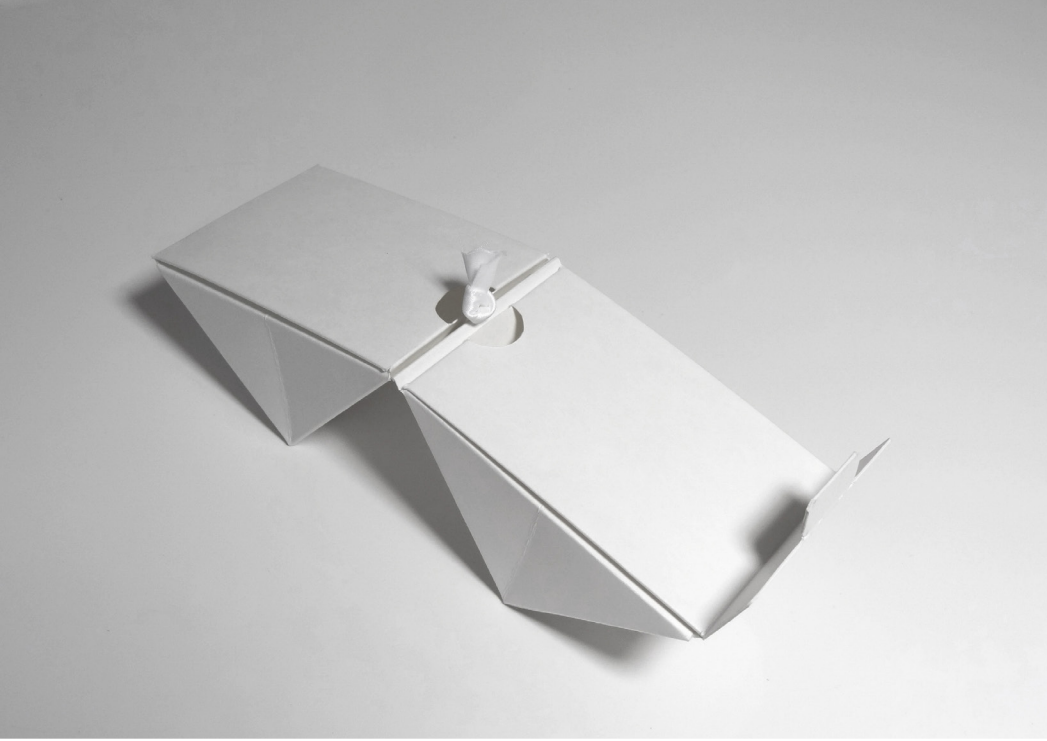

# SQUARE ORNAMENT BOX

The Square Ornament Box is the ultimate in holiday retail packaging! Containing four isolated pockets, the packaging design allows it to simultaneously hold a variety of products. What's better than one gift? Four in one!

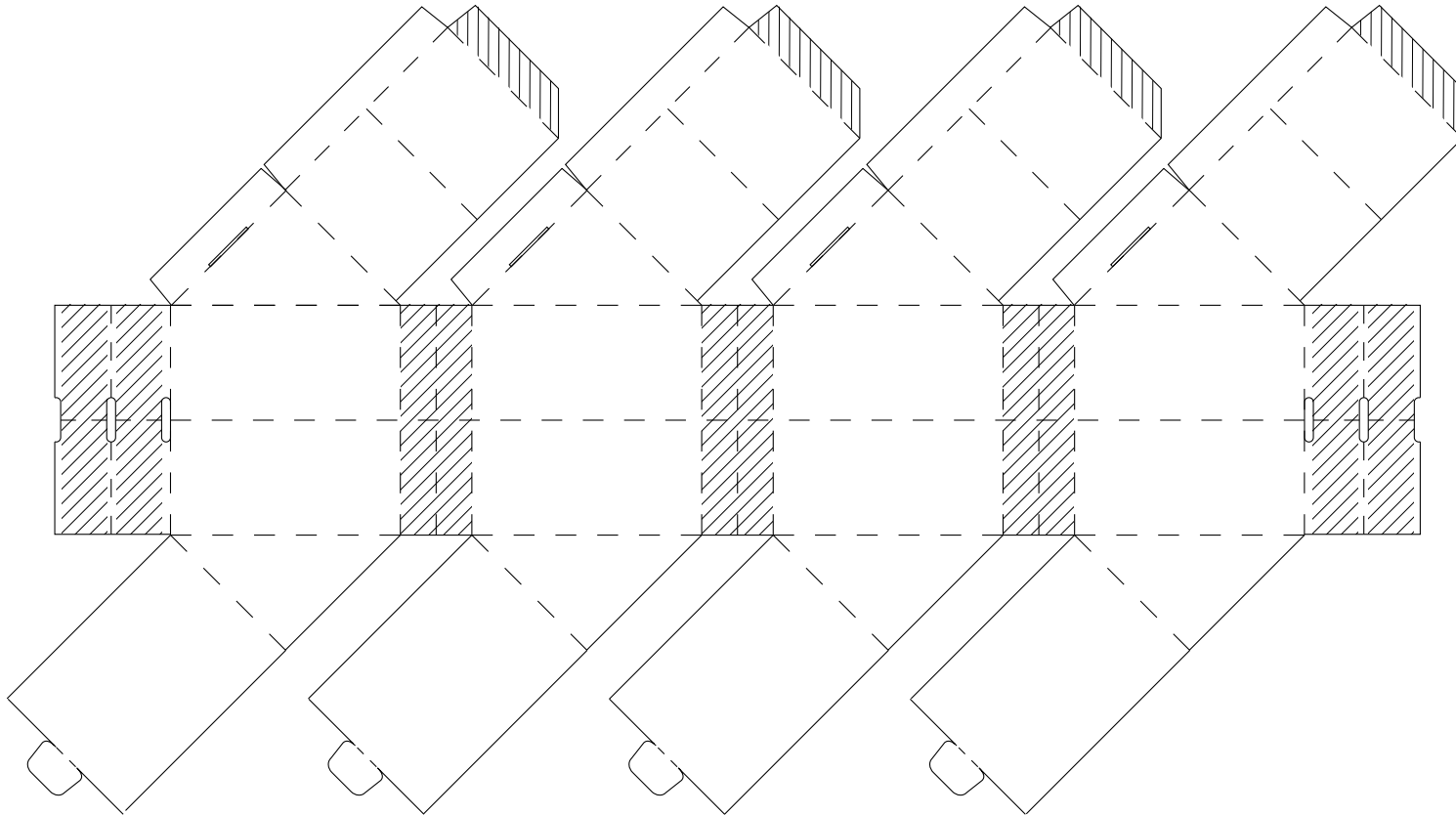

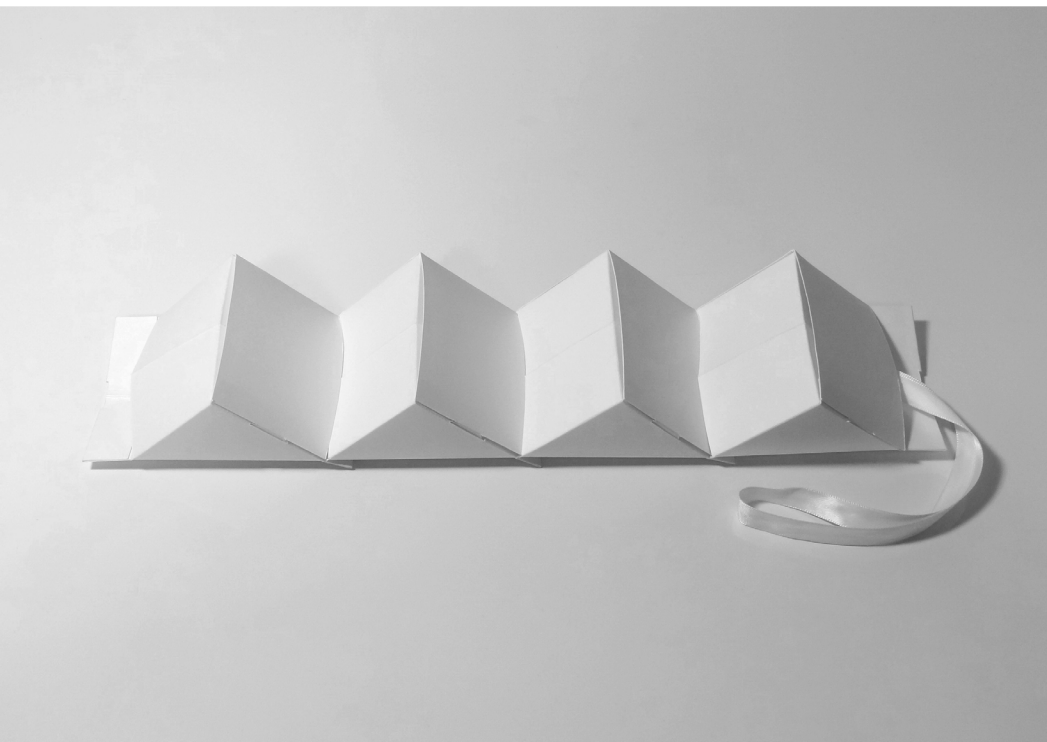
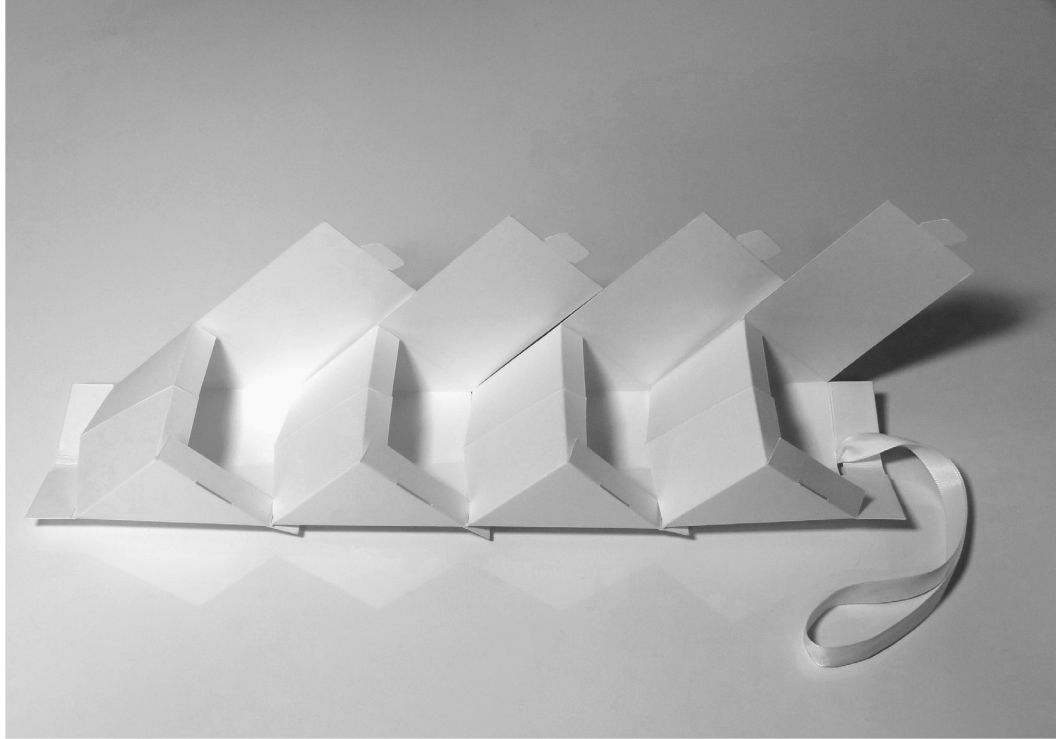

# TRIANGLE ORNAMENT BOX

This hanging Triangle Ornament Box provides a simple way to create unique decorative holiday retail packaging, gift packaging, craft packaging, and fun ways to merchandise product.

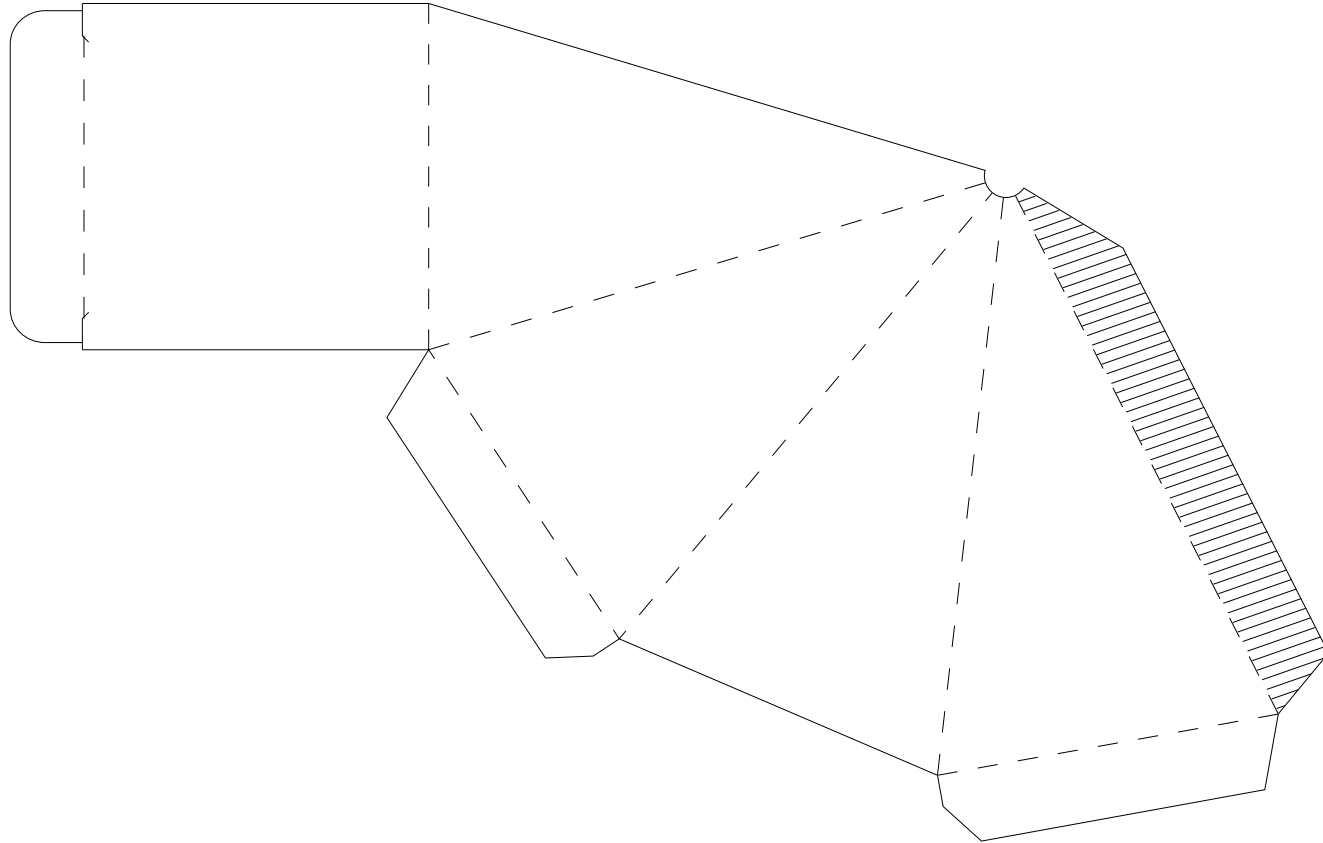

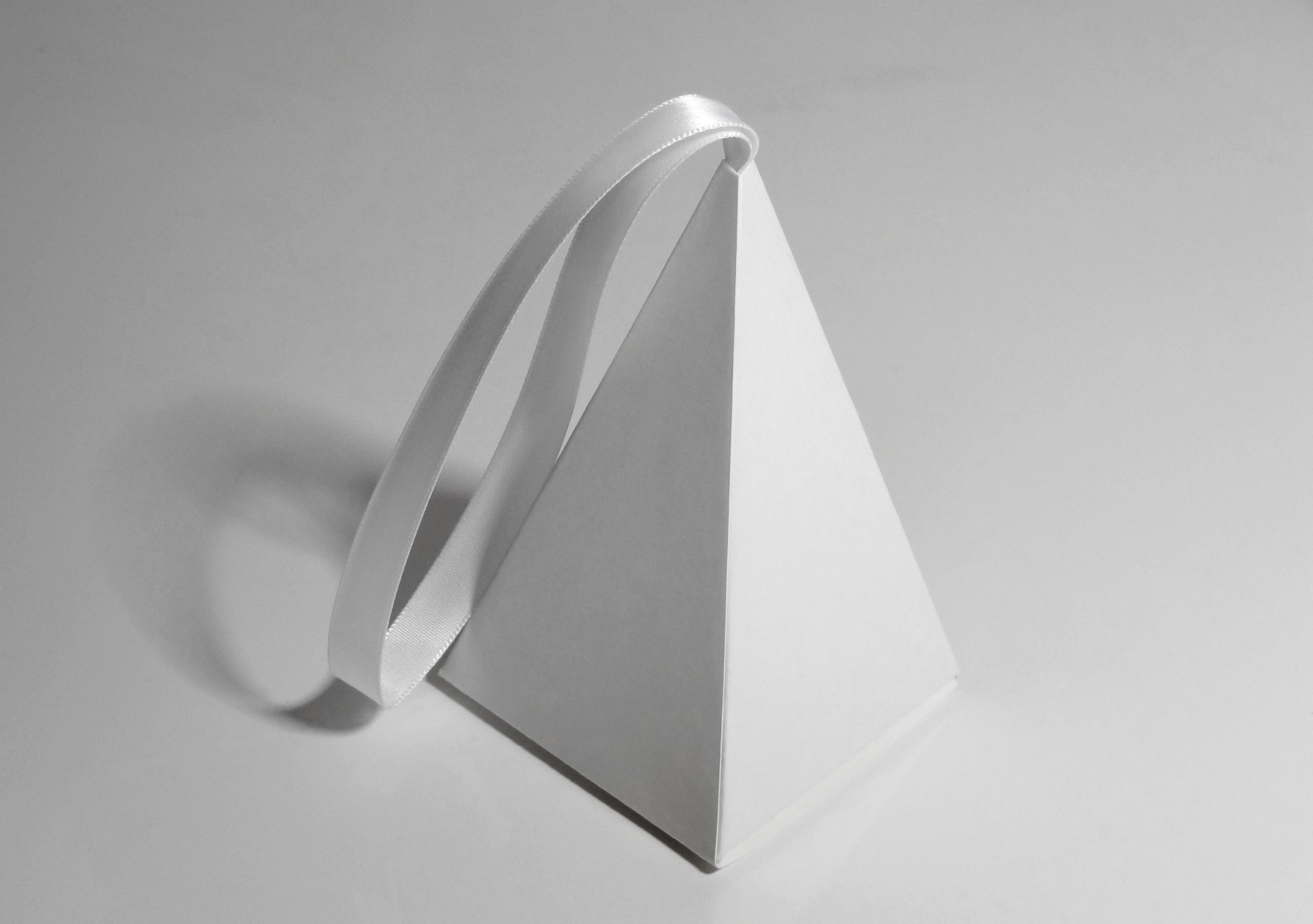

# DIAMOND ORNAMENT BOX

This diamond shaped ornamental holiday packaging design is a perfect way to hang a small gifts or gift cards from the tree. Imagine the surprise when it's opened! The box opens from the side to reveal its contents.

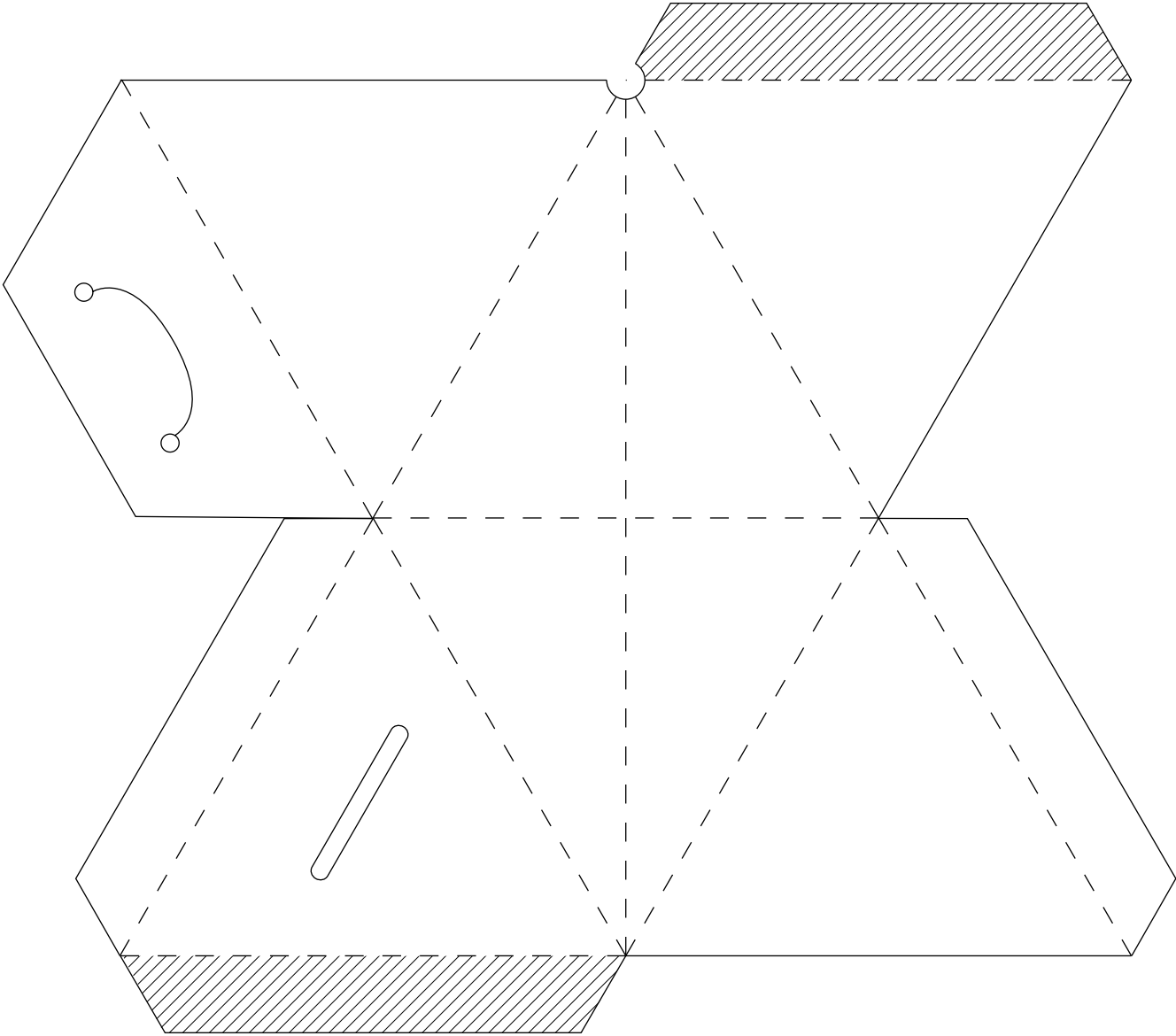



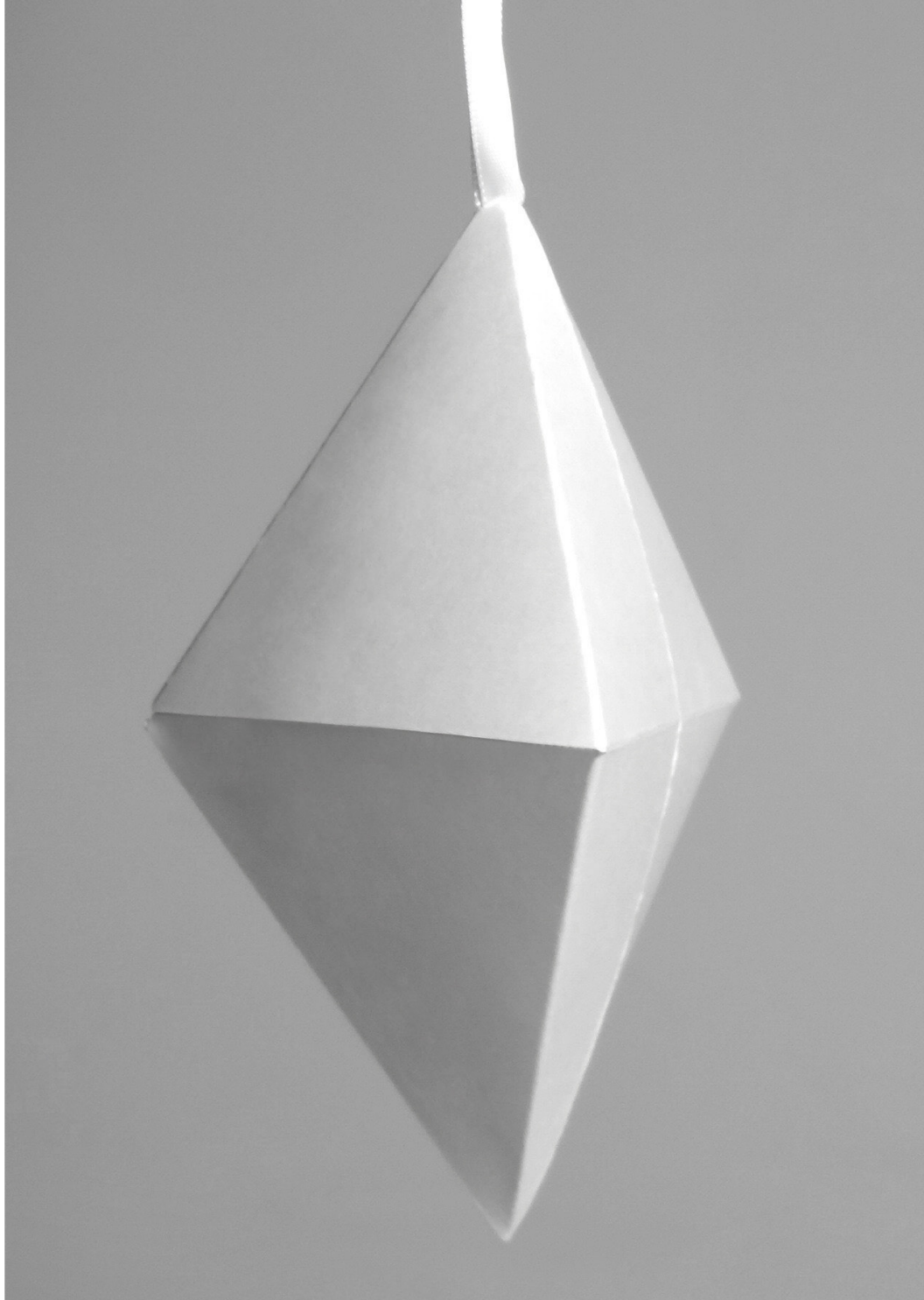
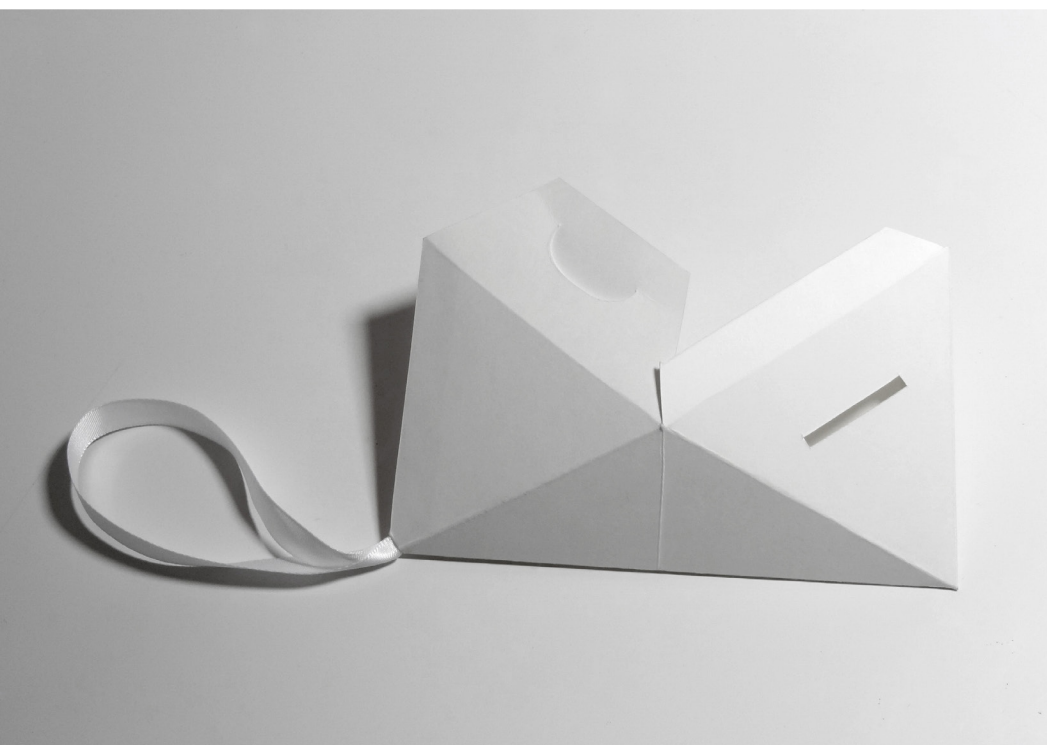
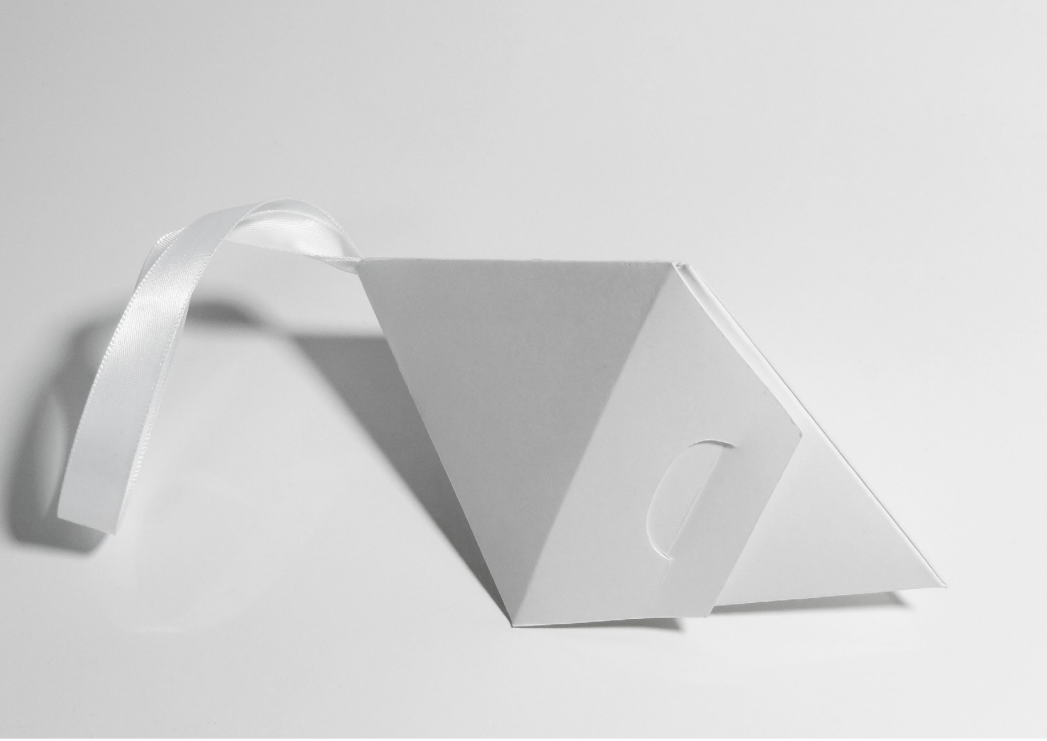

# TRIANGLE BOX

The folding Triangle Box opens from the side and can be presented in either a horizontal or vertical presentation.

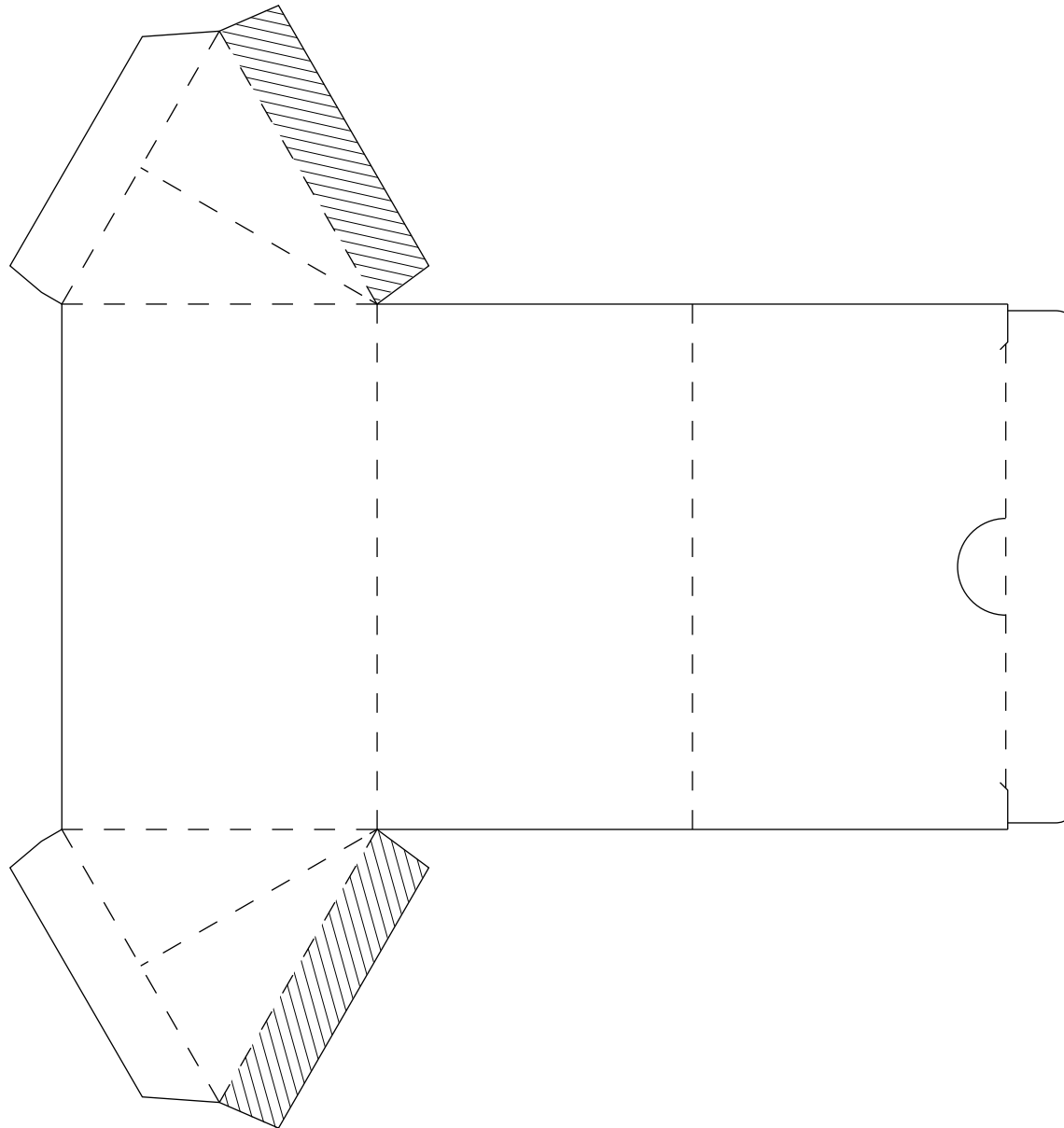

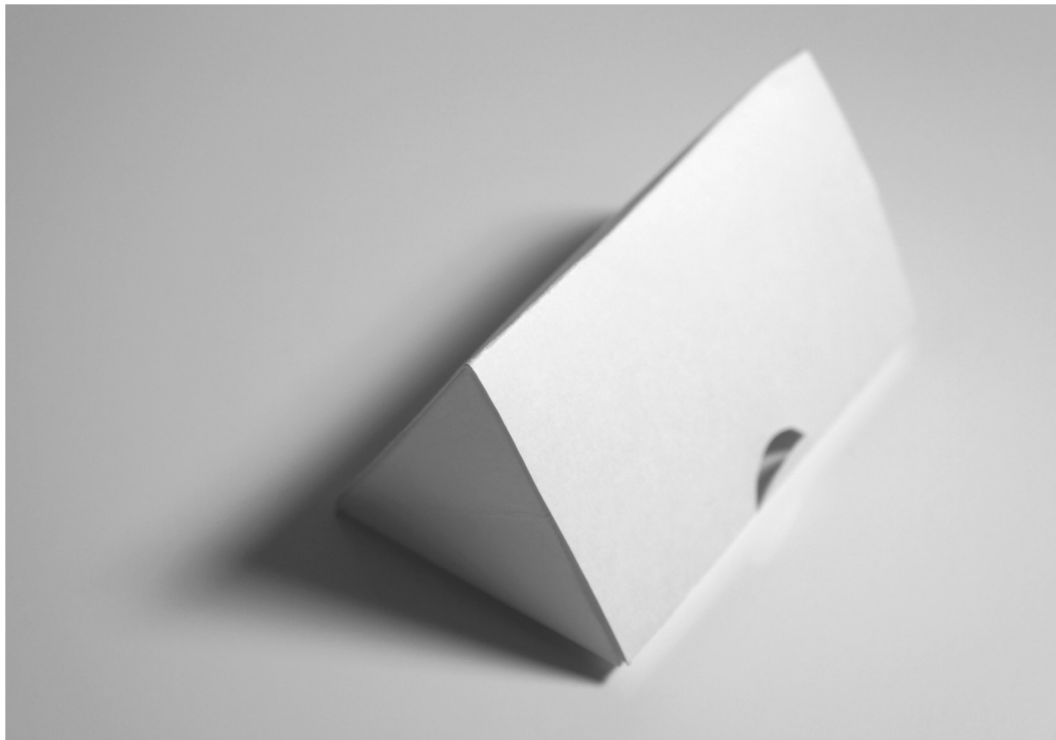
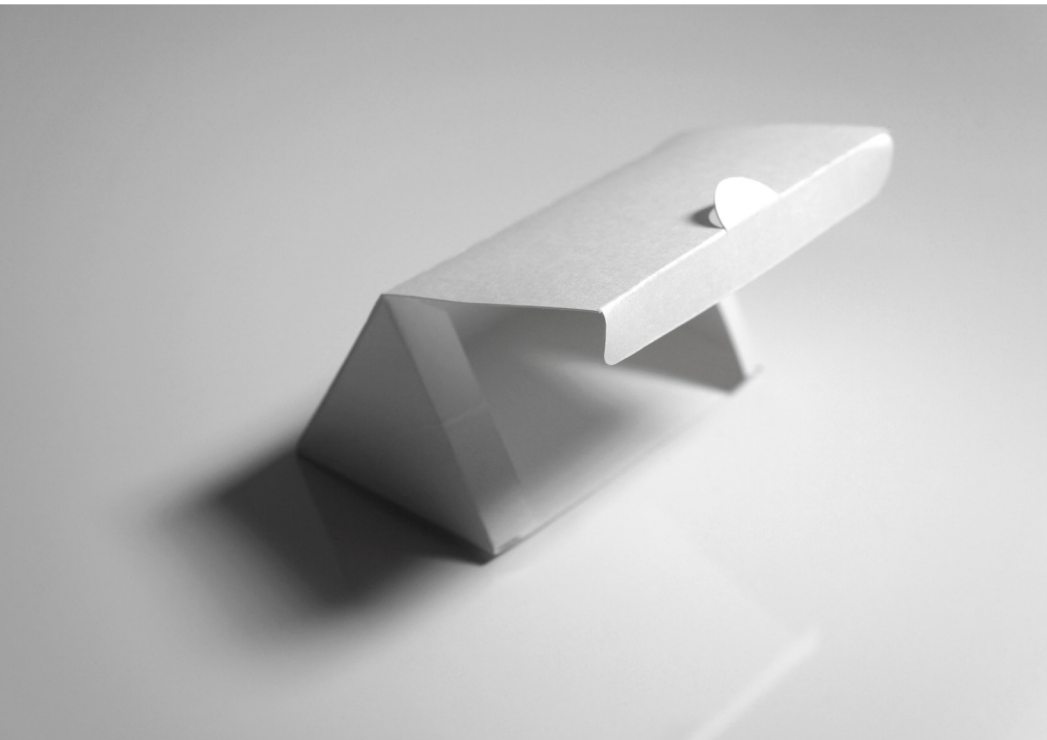
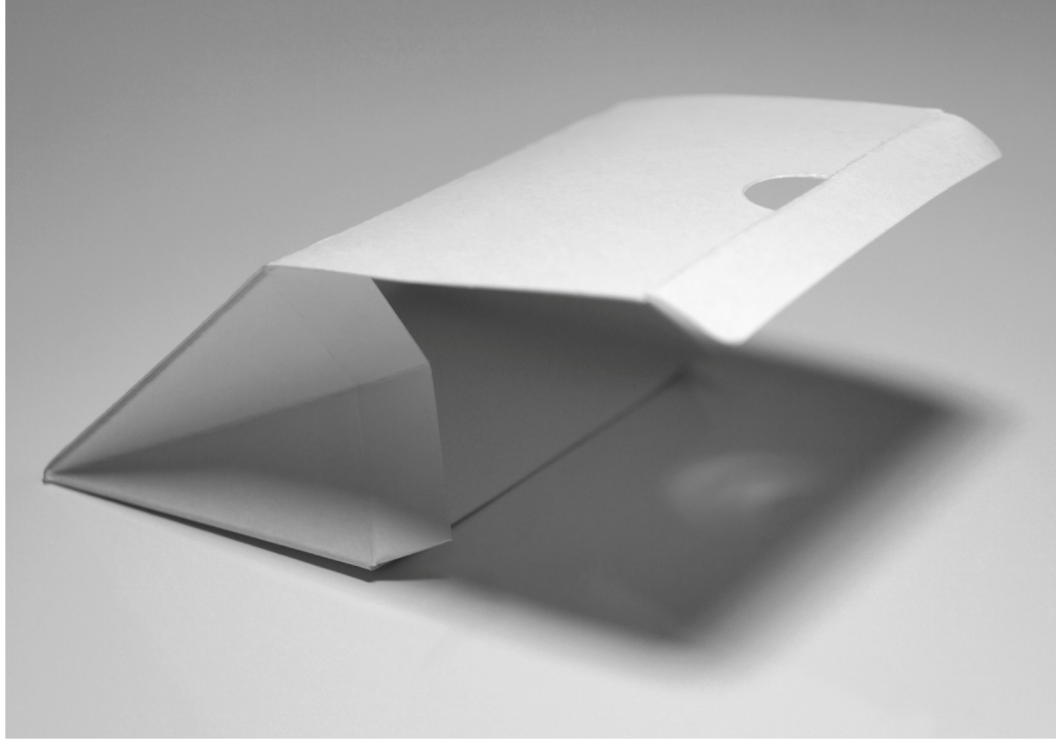
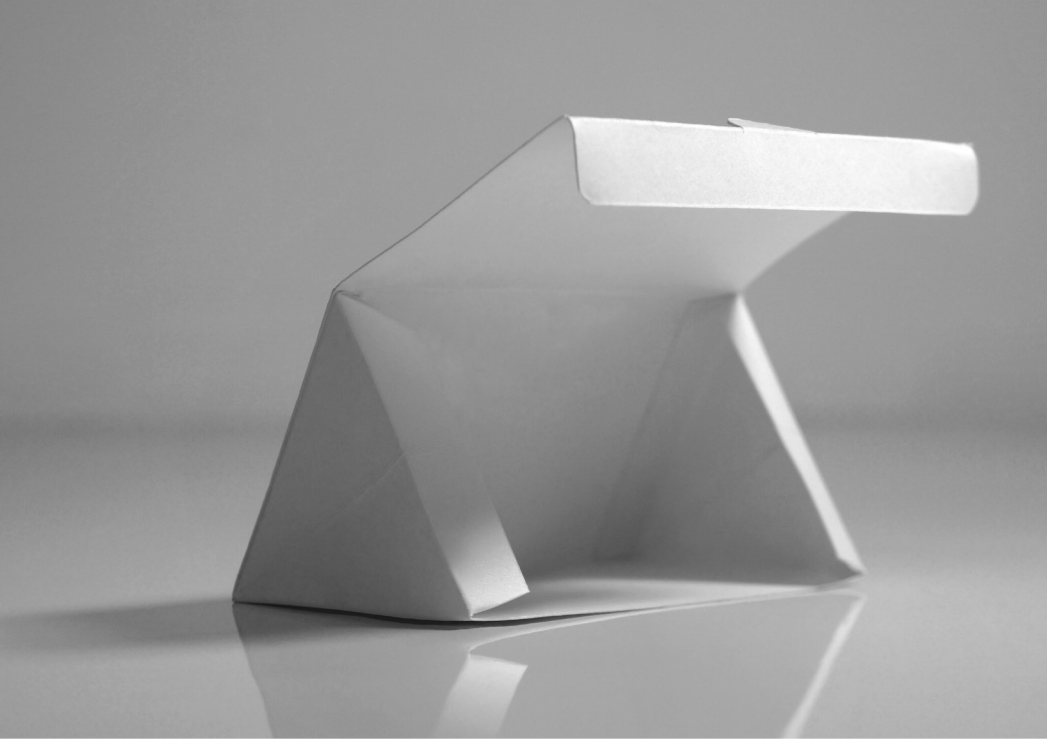

# TETRIS®-INSPIRED BOXES

Sometimes packaging design just has to be fun! Based on the classic Russian video game, these boxes come in the classic puzzle shapes, taking the game from virtual to physical! Best of all, these boxes can be taken from a popping 3D to a flat, folded 2D.

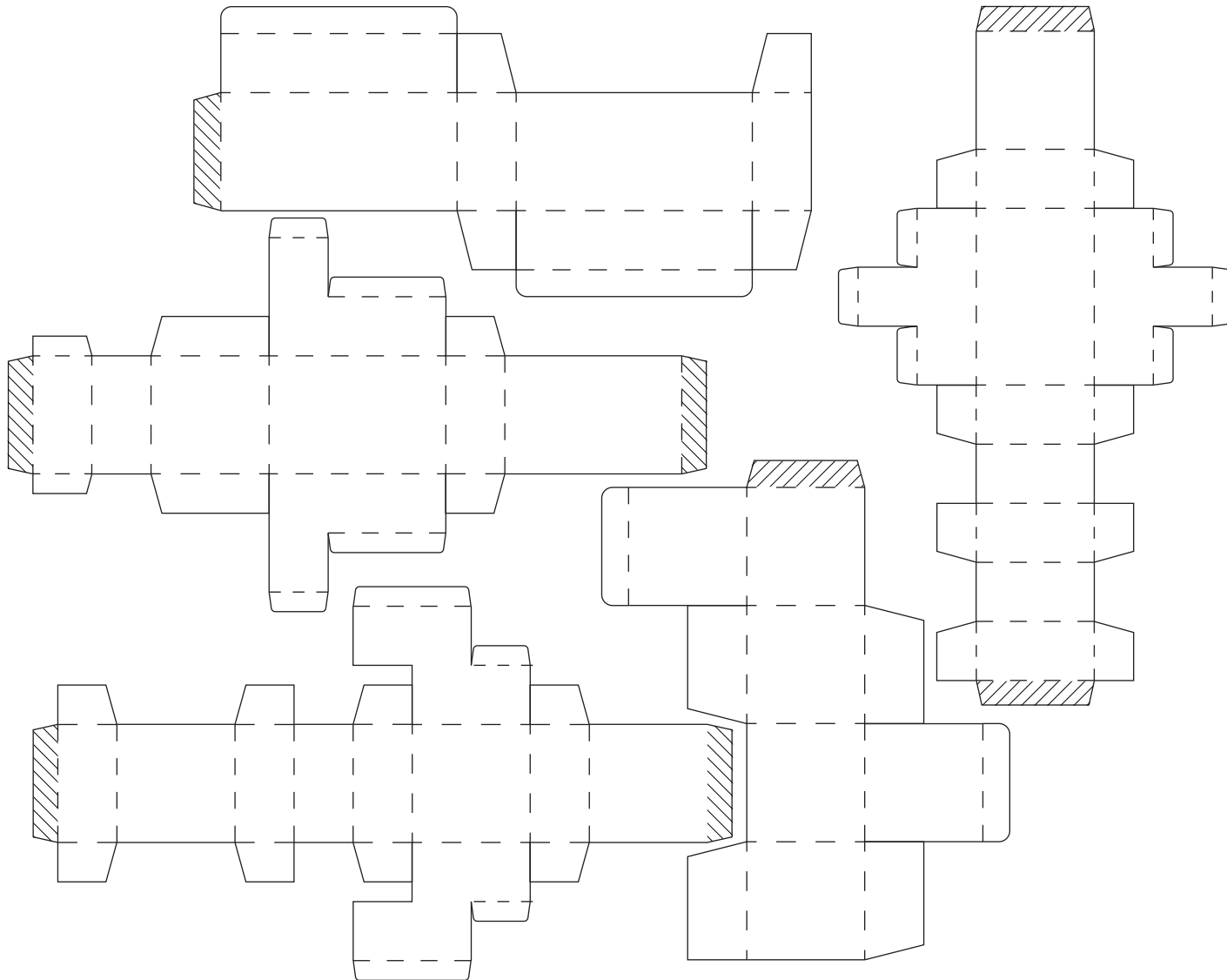

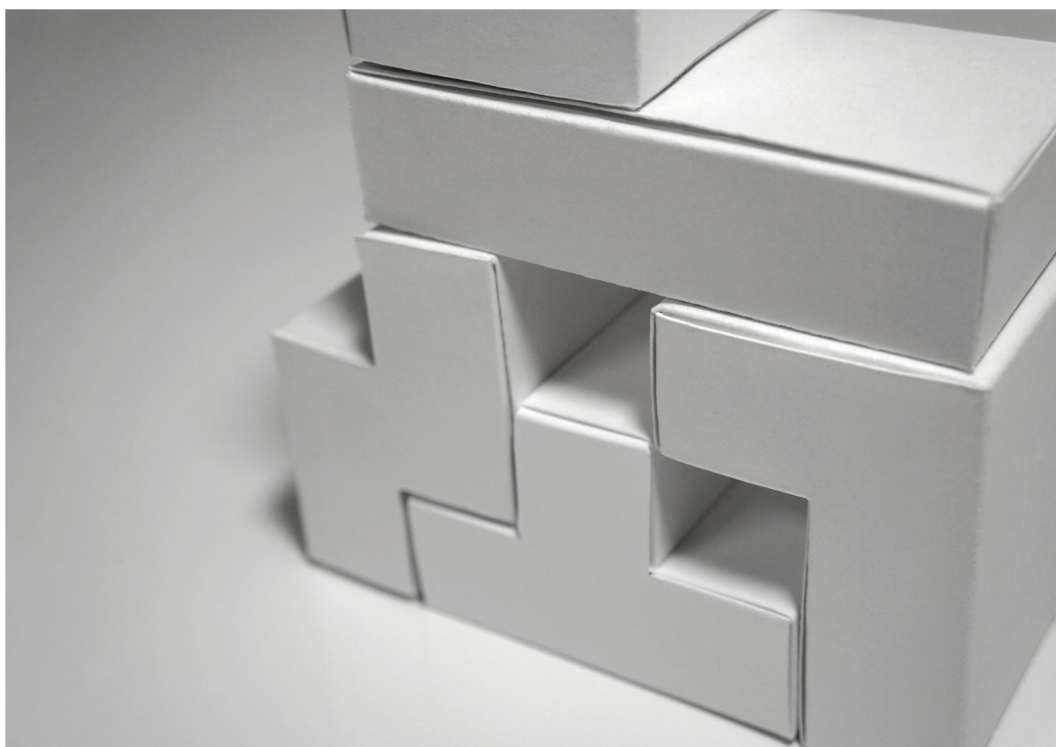
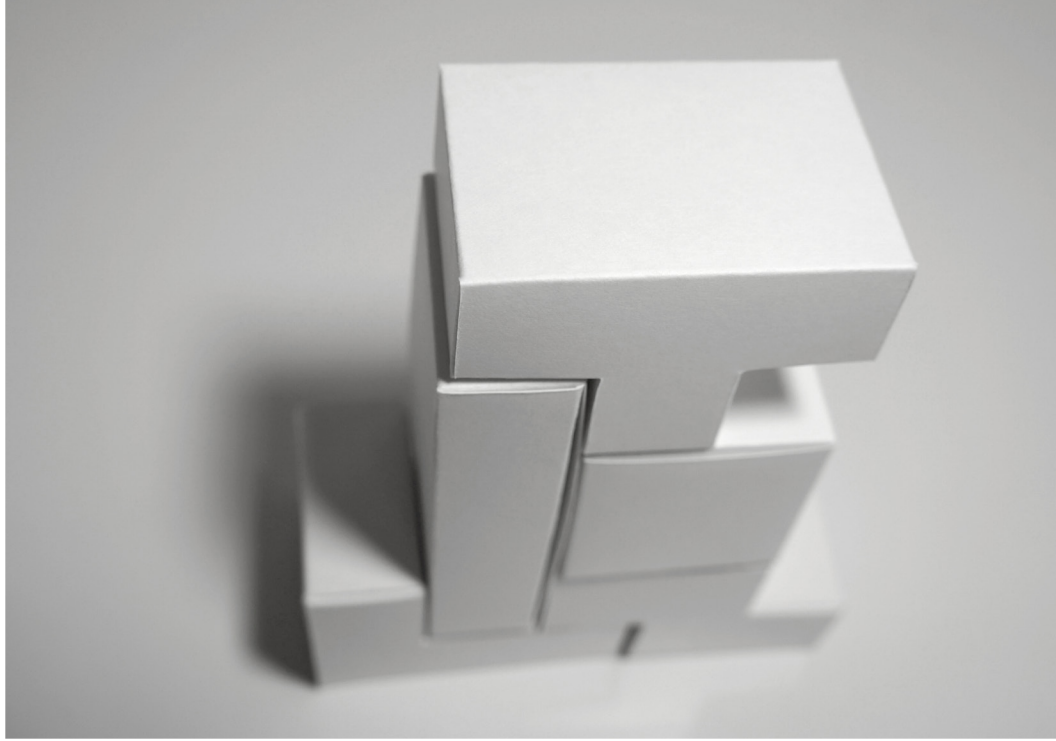

# V CLOSURE BOX

This packaging design features a v-shaped secret pocket that the lid tucks into. The layered pocket could be complemented by contrasting colors or finishes in printing.

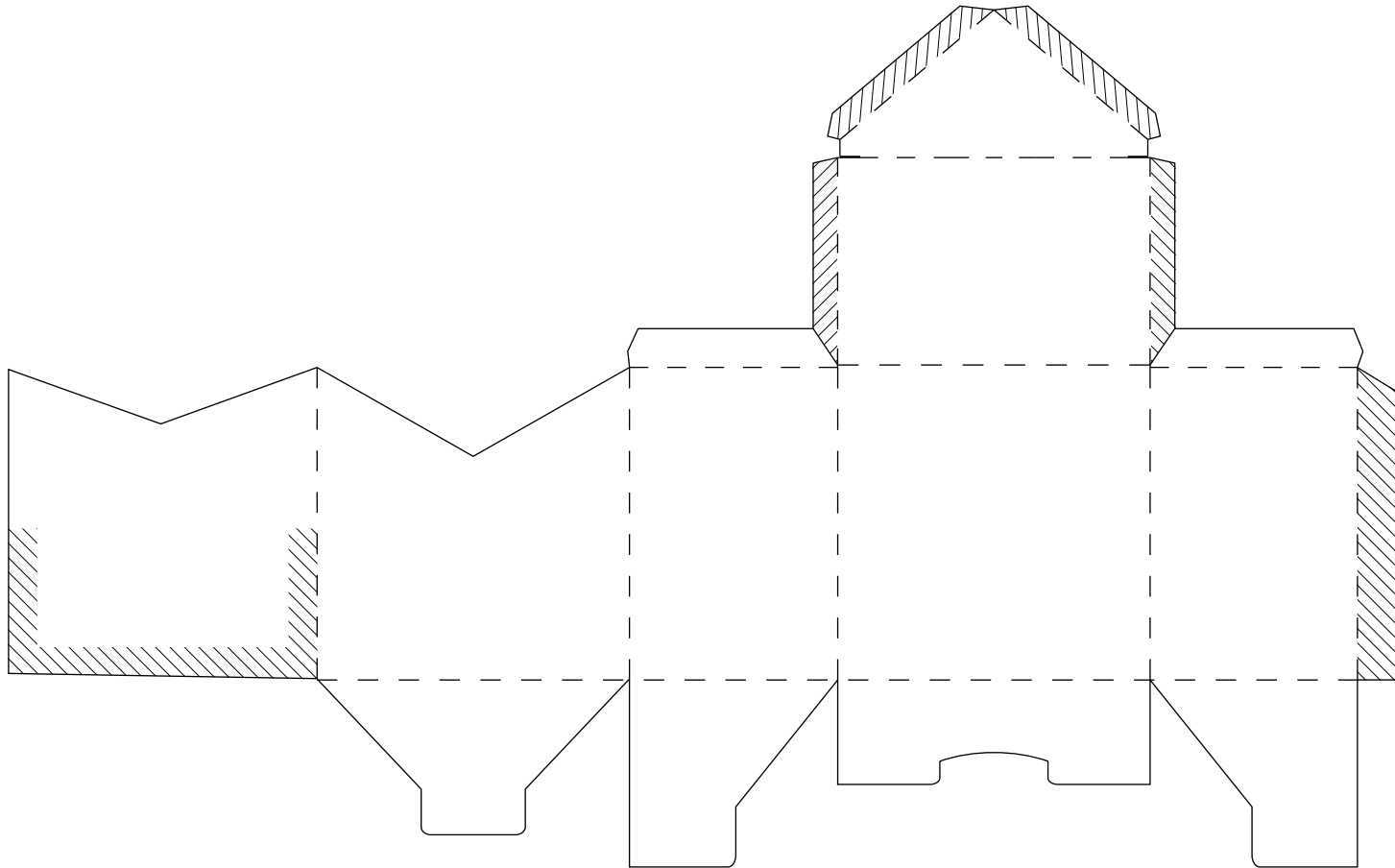

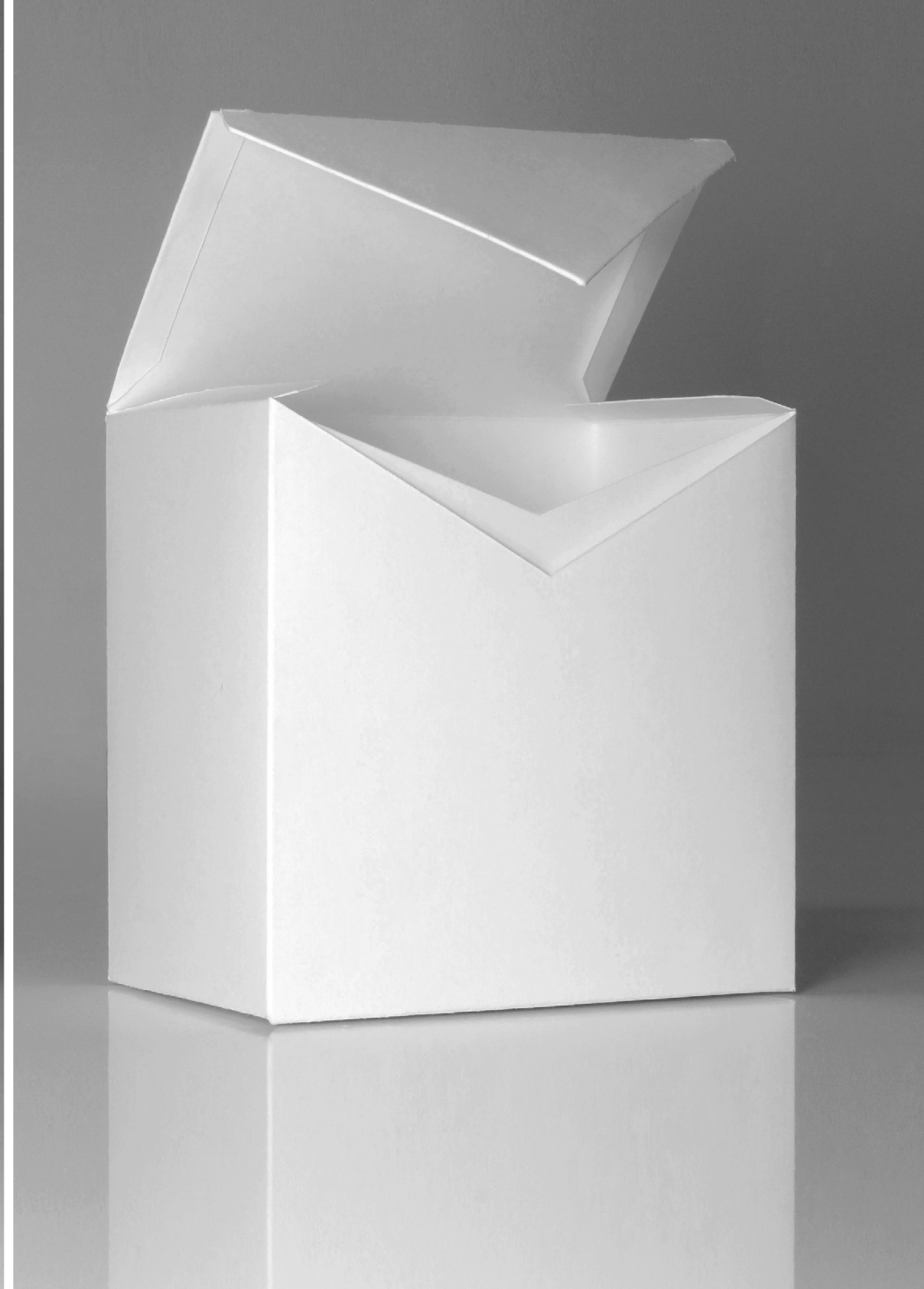

# HINGED PYRAMID

A pyramid to hold treasured product - this Hinged Pyramid box uses its dramatic form to stand out from the crowd and to draw the user's attention to the top compartment holding the product.

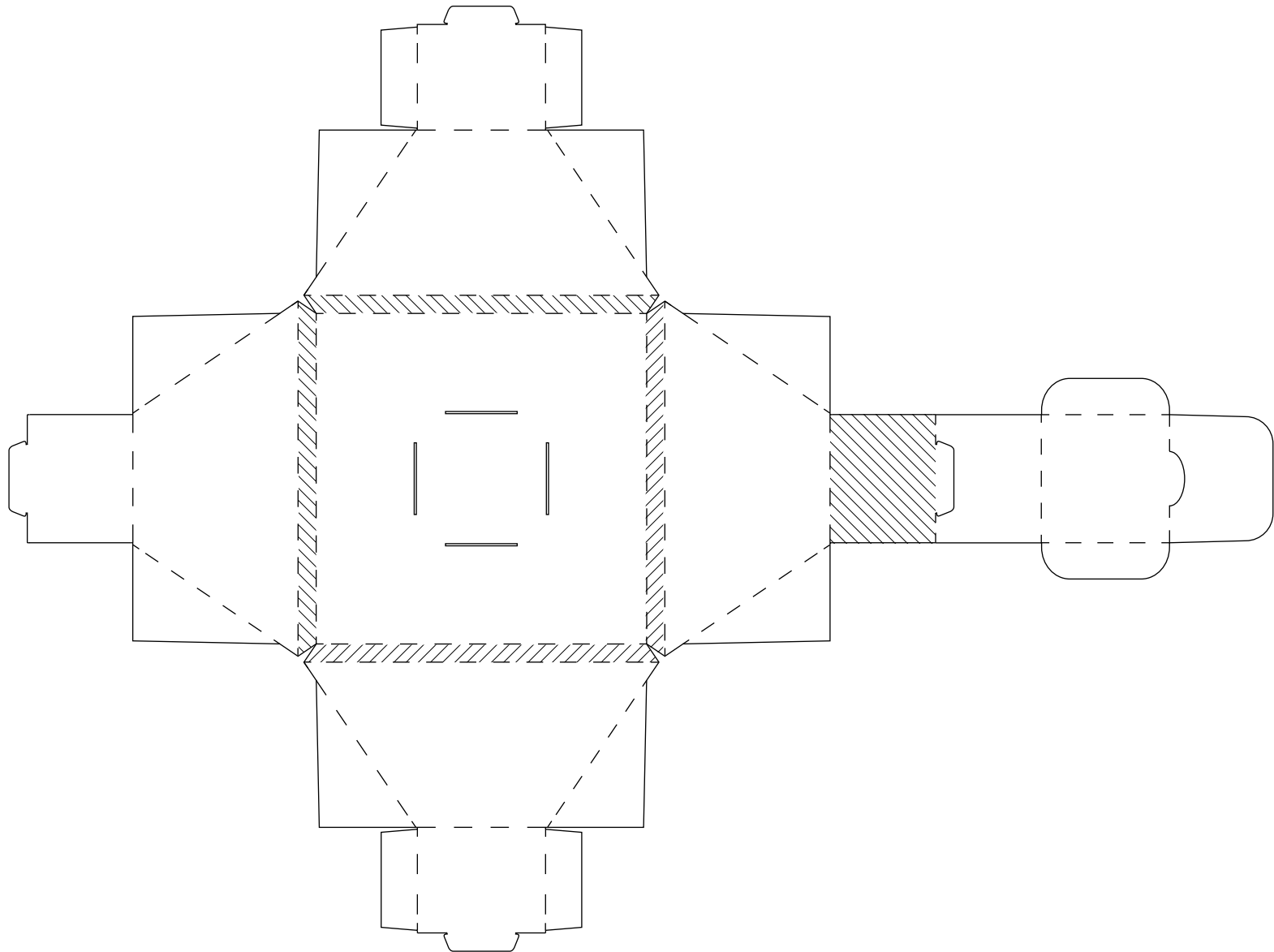



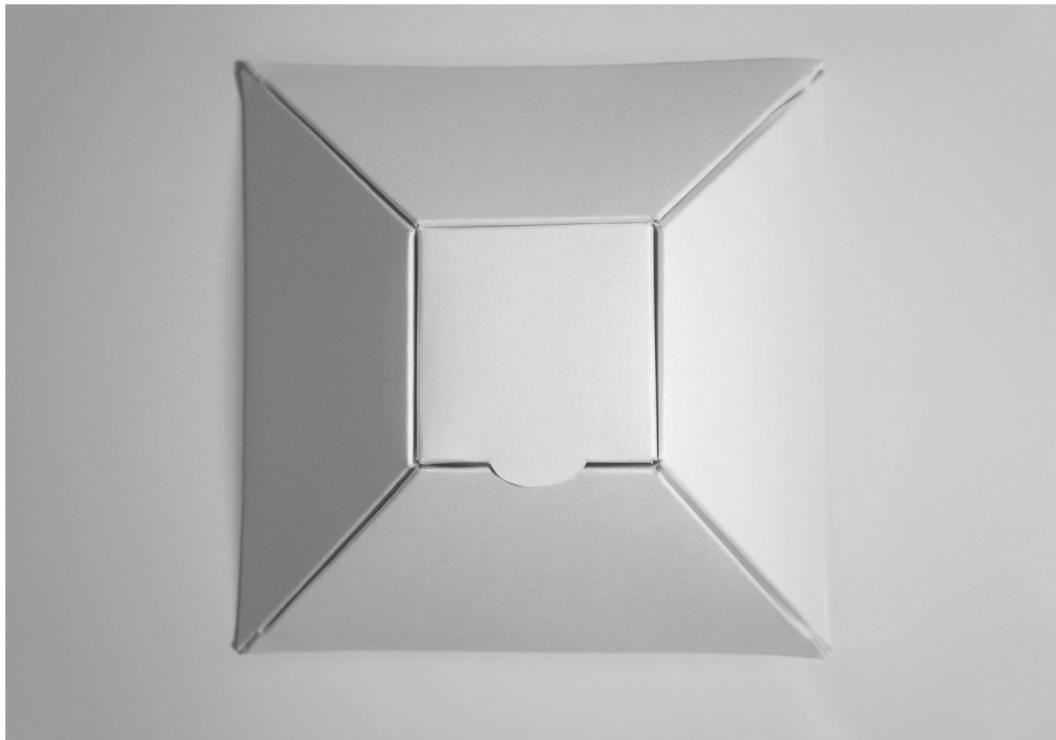
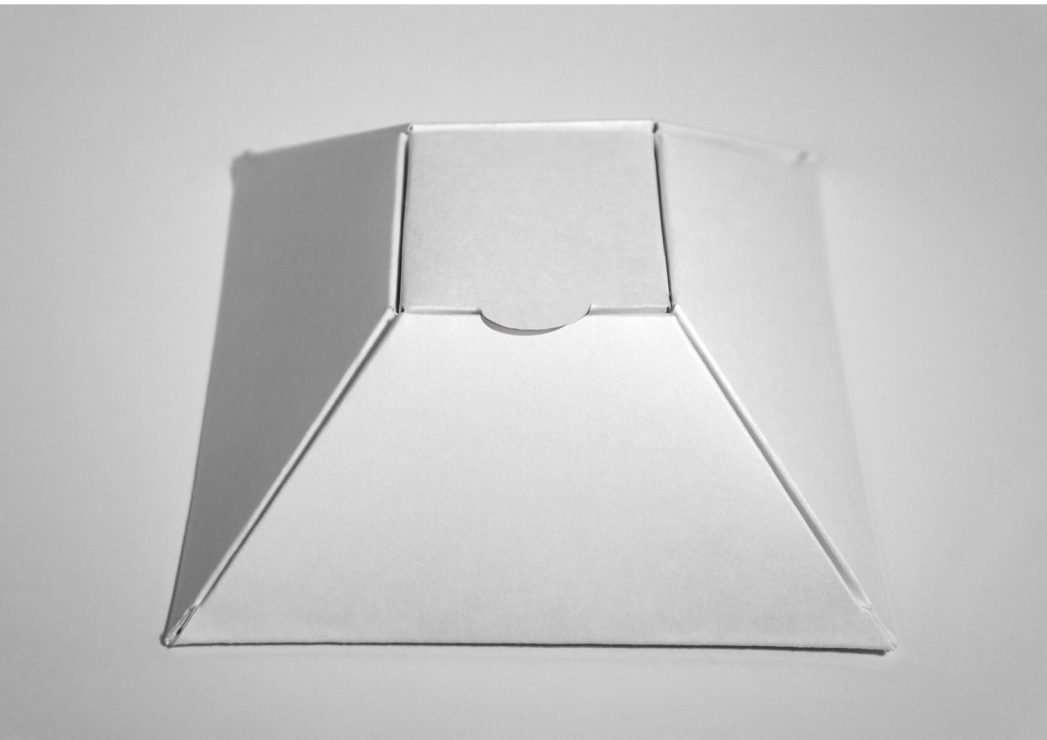
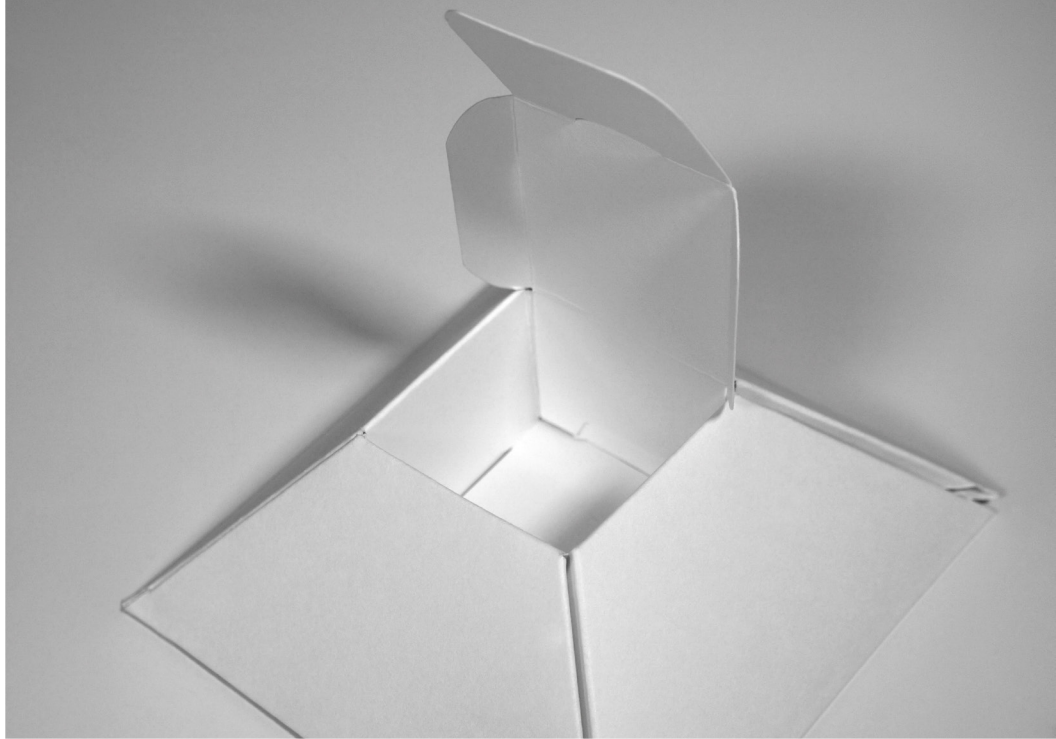

# GLUE-LESS FRAME BOX

The Glue-Less Frame Box provides product protection from bumps and dents while remaining glue-free. The frame also provides a wide border to highlight the product inside.

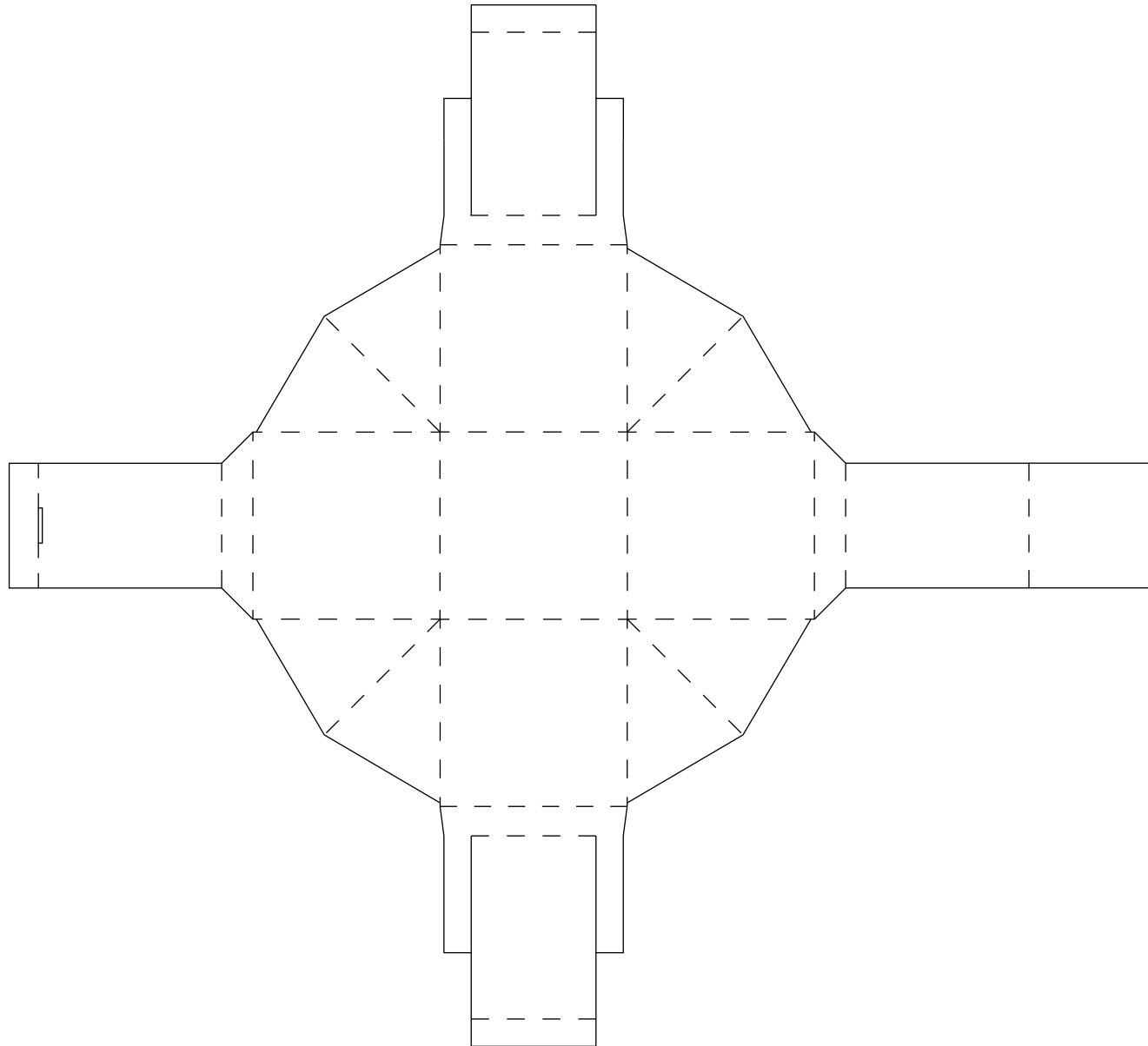

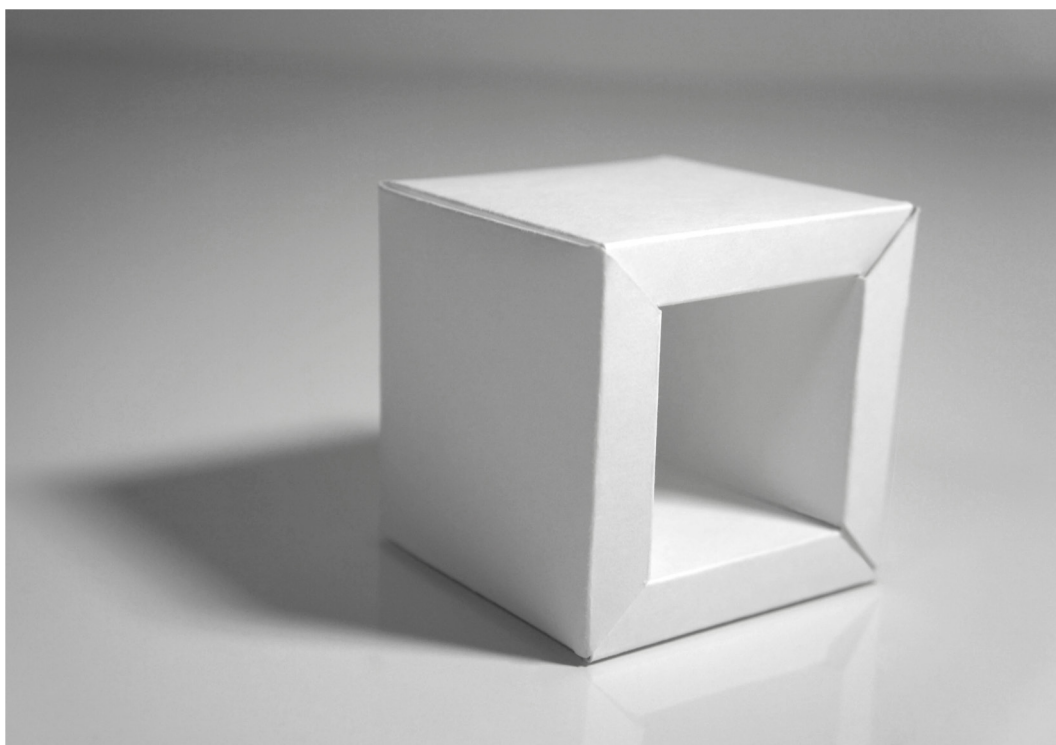
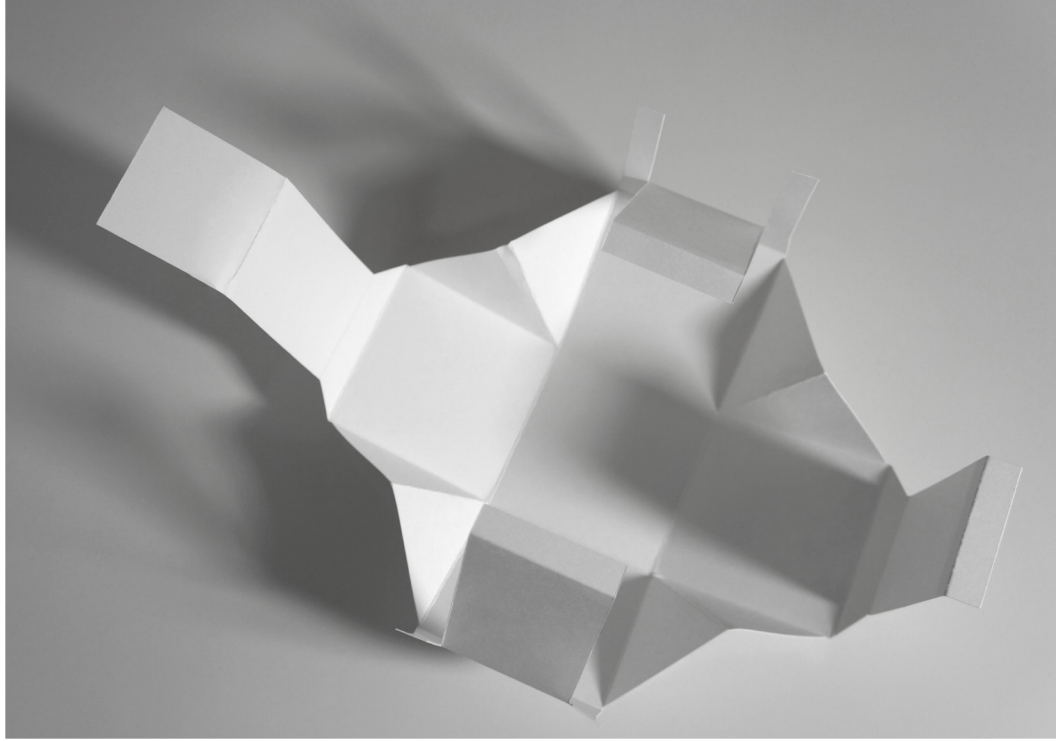
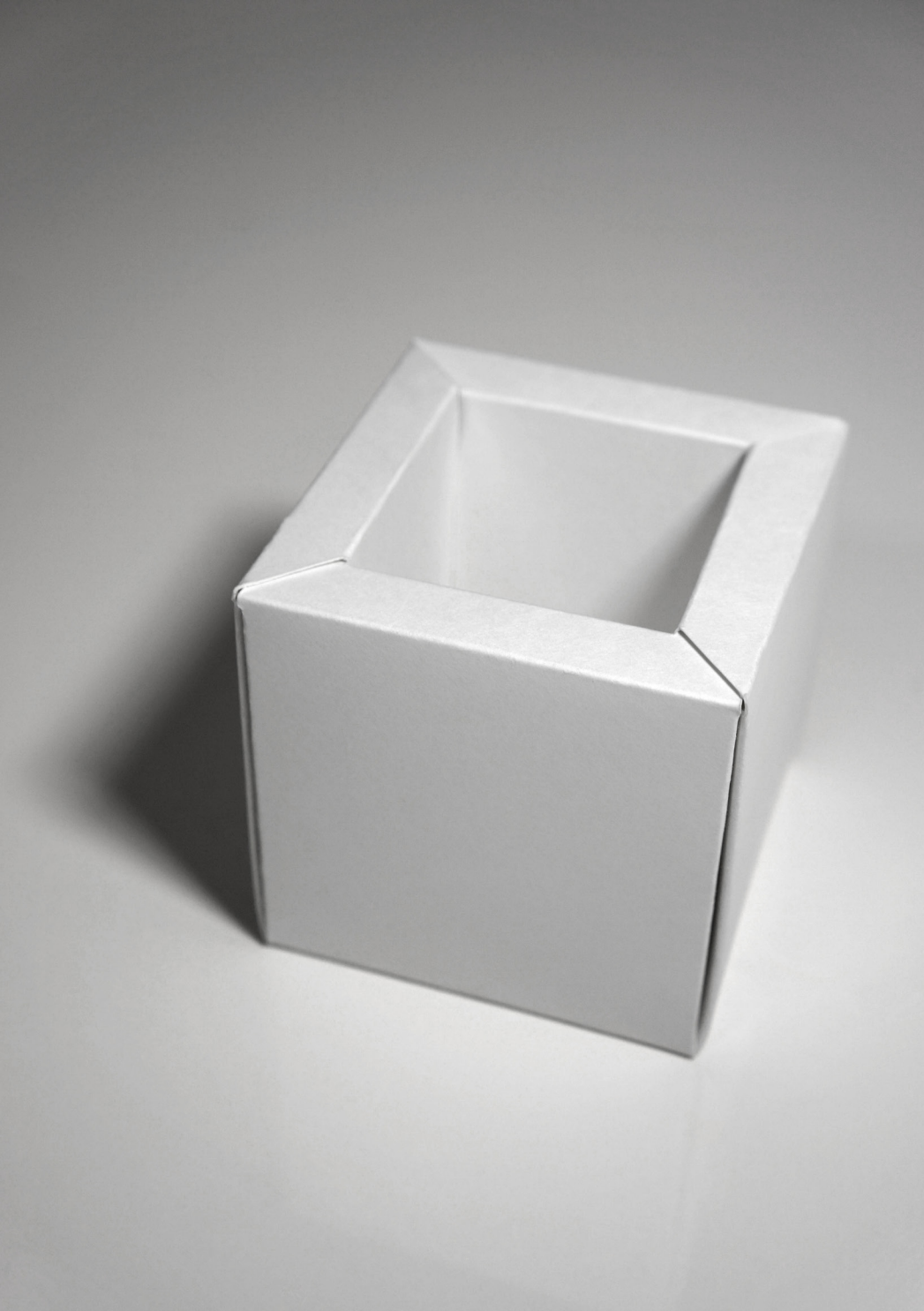

# INTEGRATED DIVIDER BOX

This double door packaging design is reminiscent of a cabinet, utilizing built-in dividers to organize and sort its contents. While it may look like it has multiple parts, its only one sheet that folds flat.

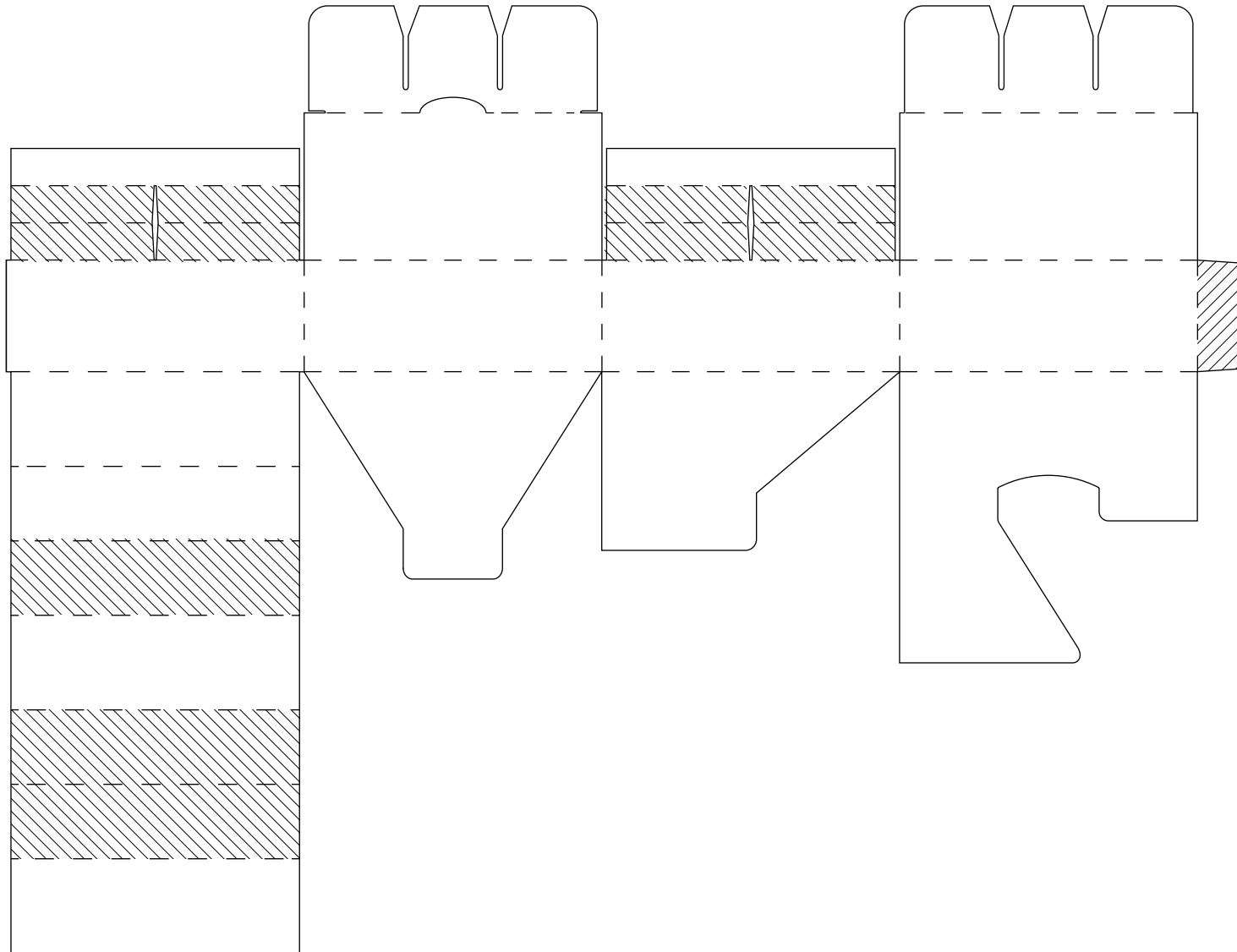

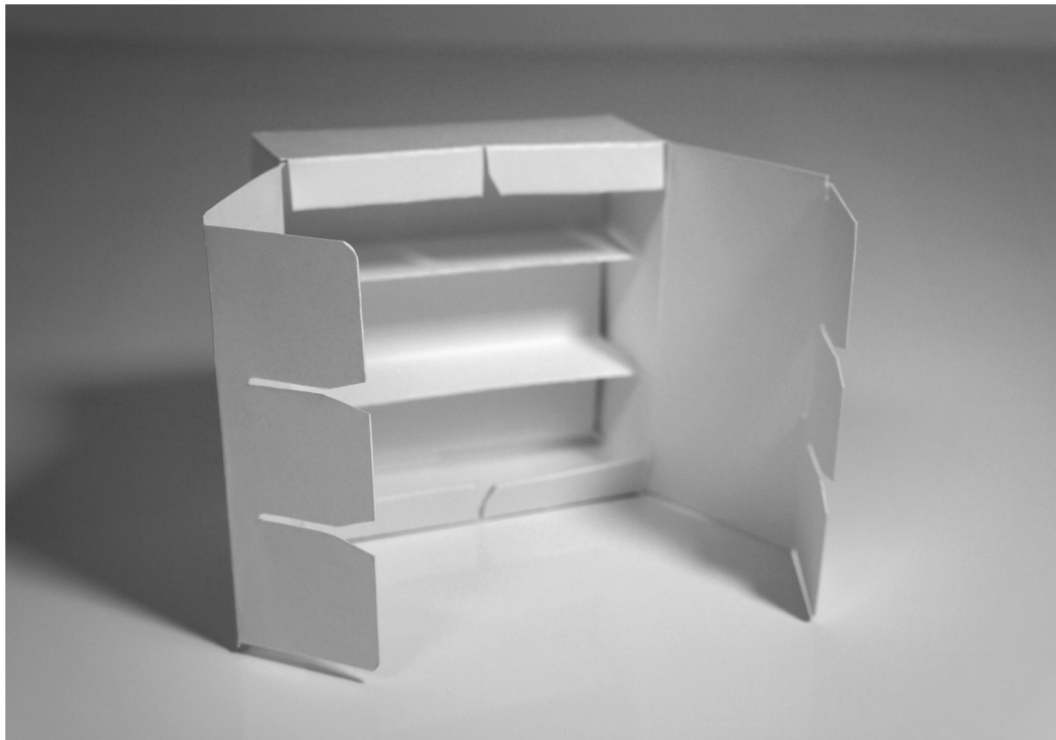
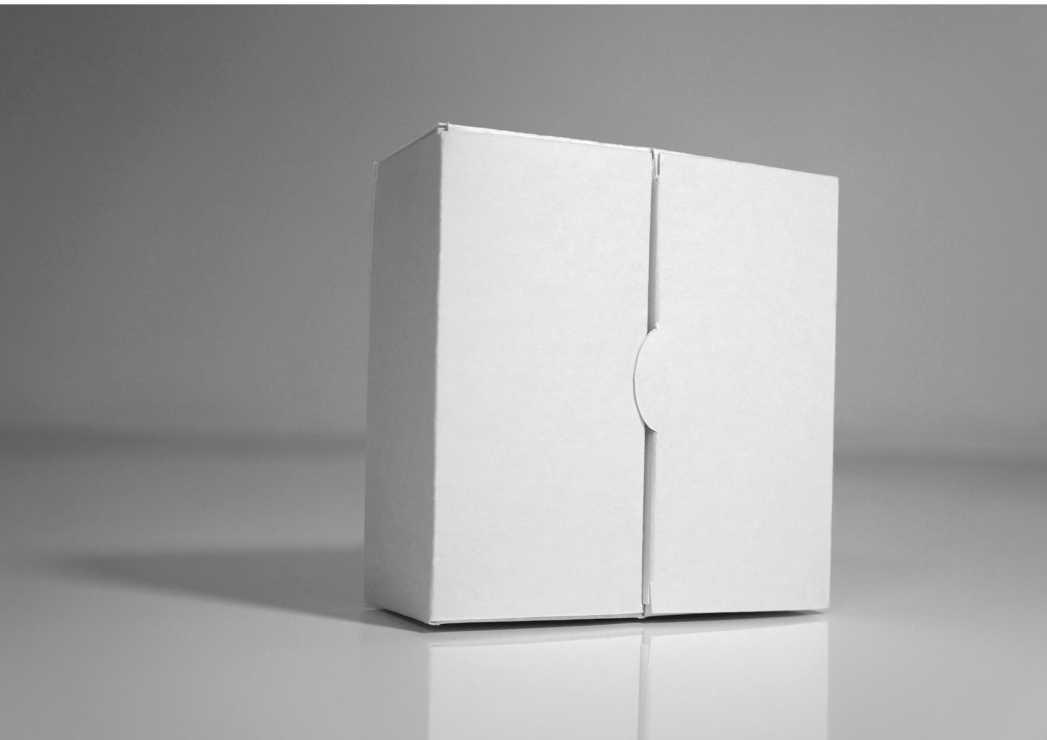
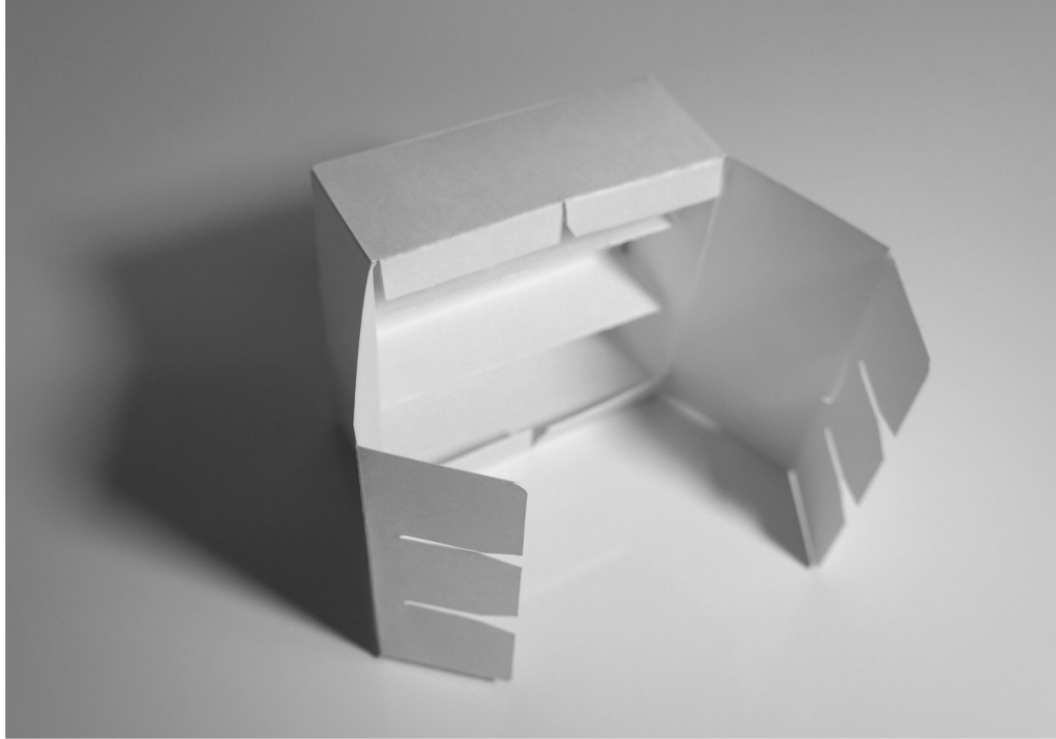
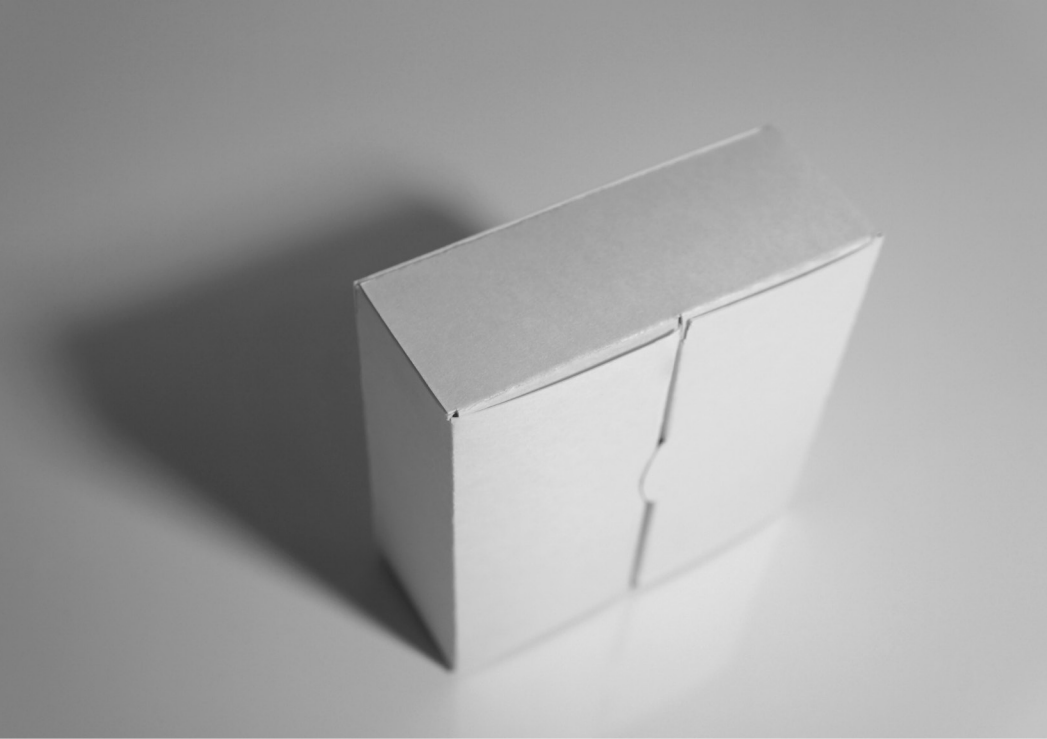

# SLANTED BOX WITH INSERT

This slanted box has the insert built into the dieline so that there are no loose parts. The diecut holes on the insert can be adjusted to hold anything from chocolates to fragrance samples.

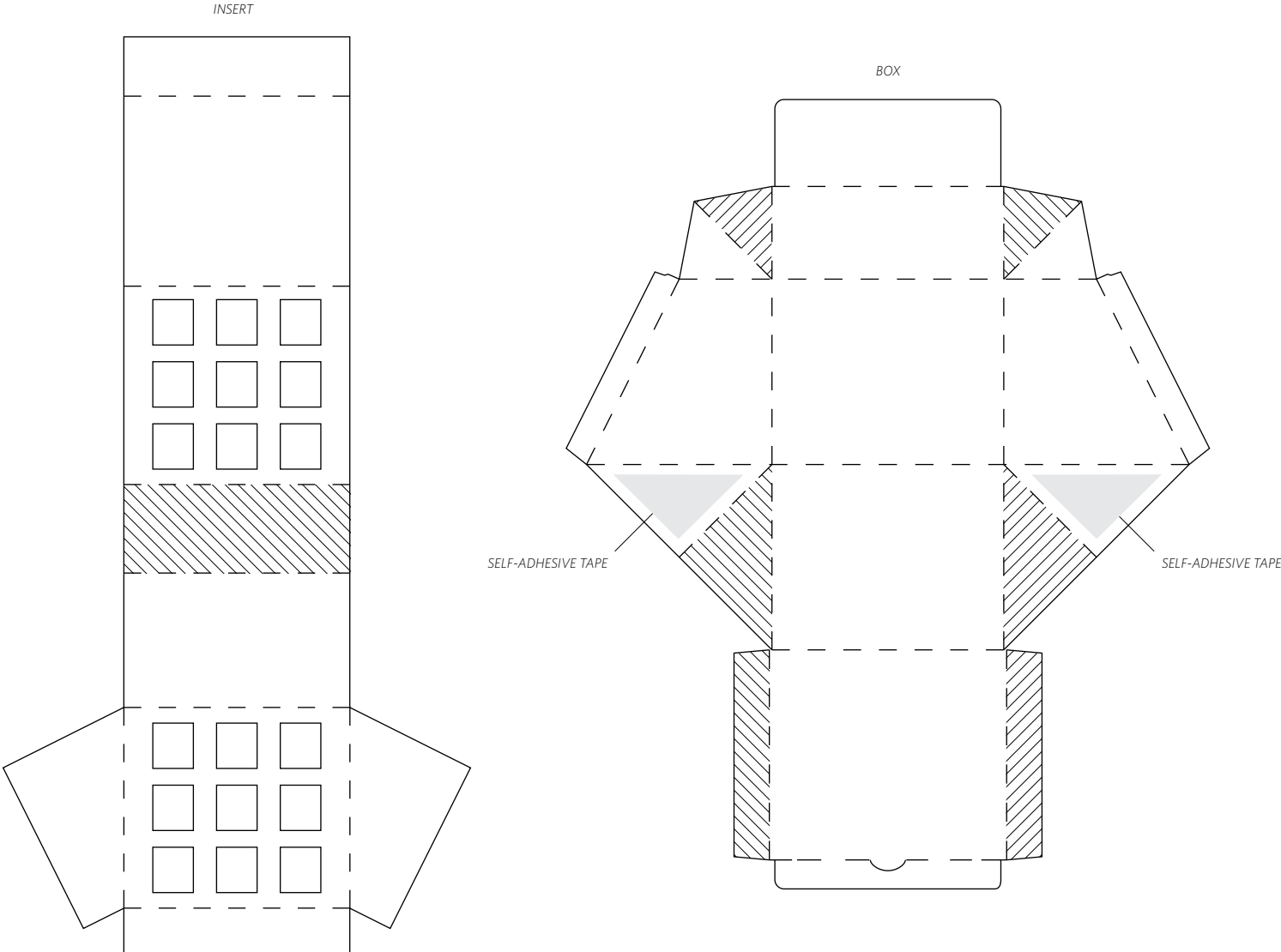

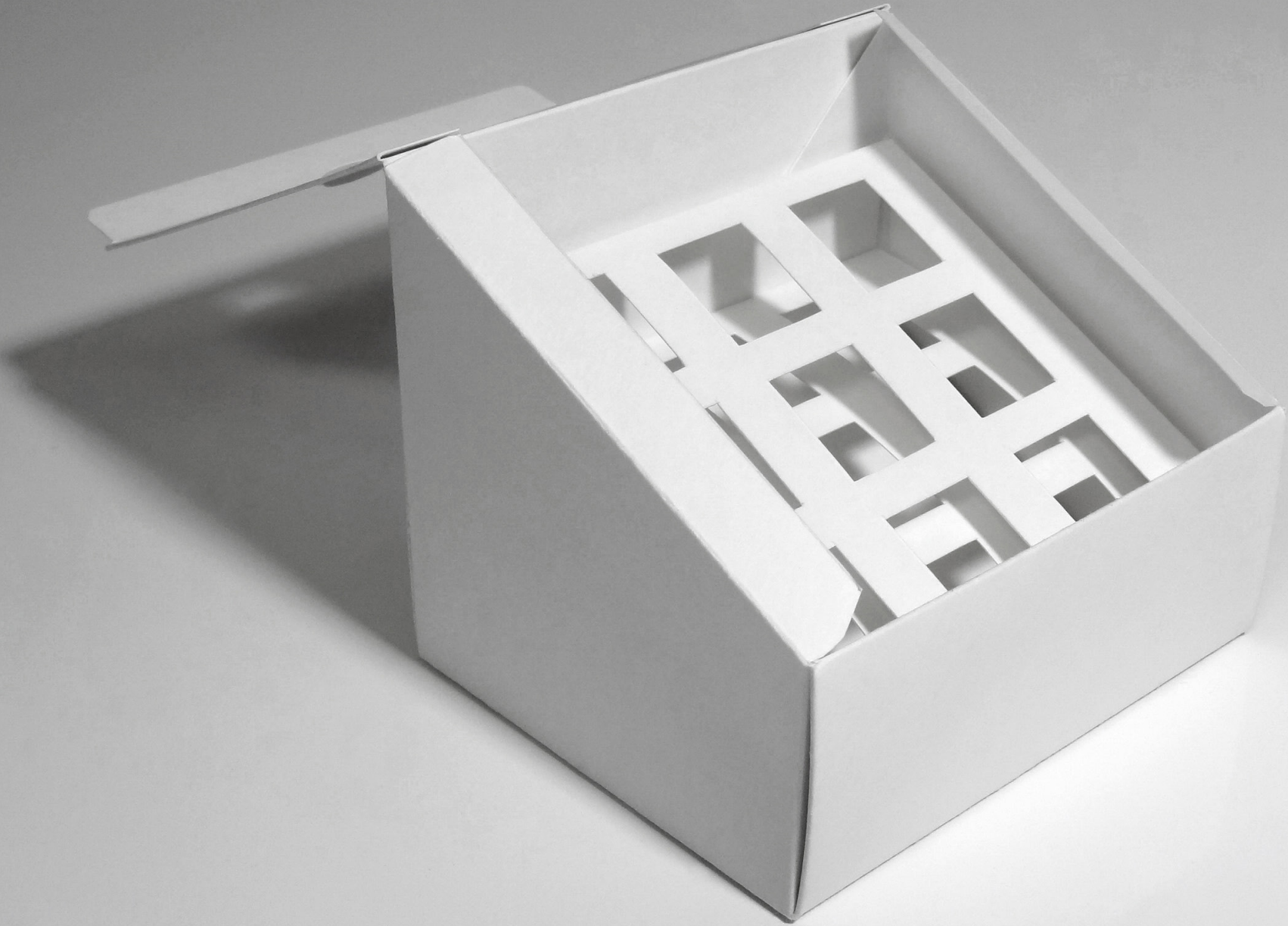

# A-FRAME PILLOW BOX

This packaging design takes the soft curves of a standard pillow box, and allows it to stand freely.

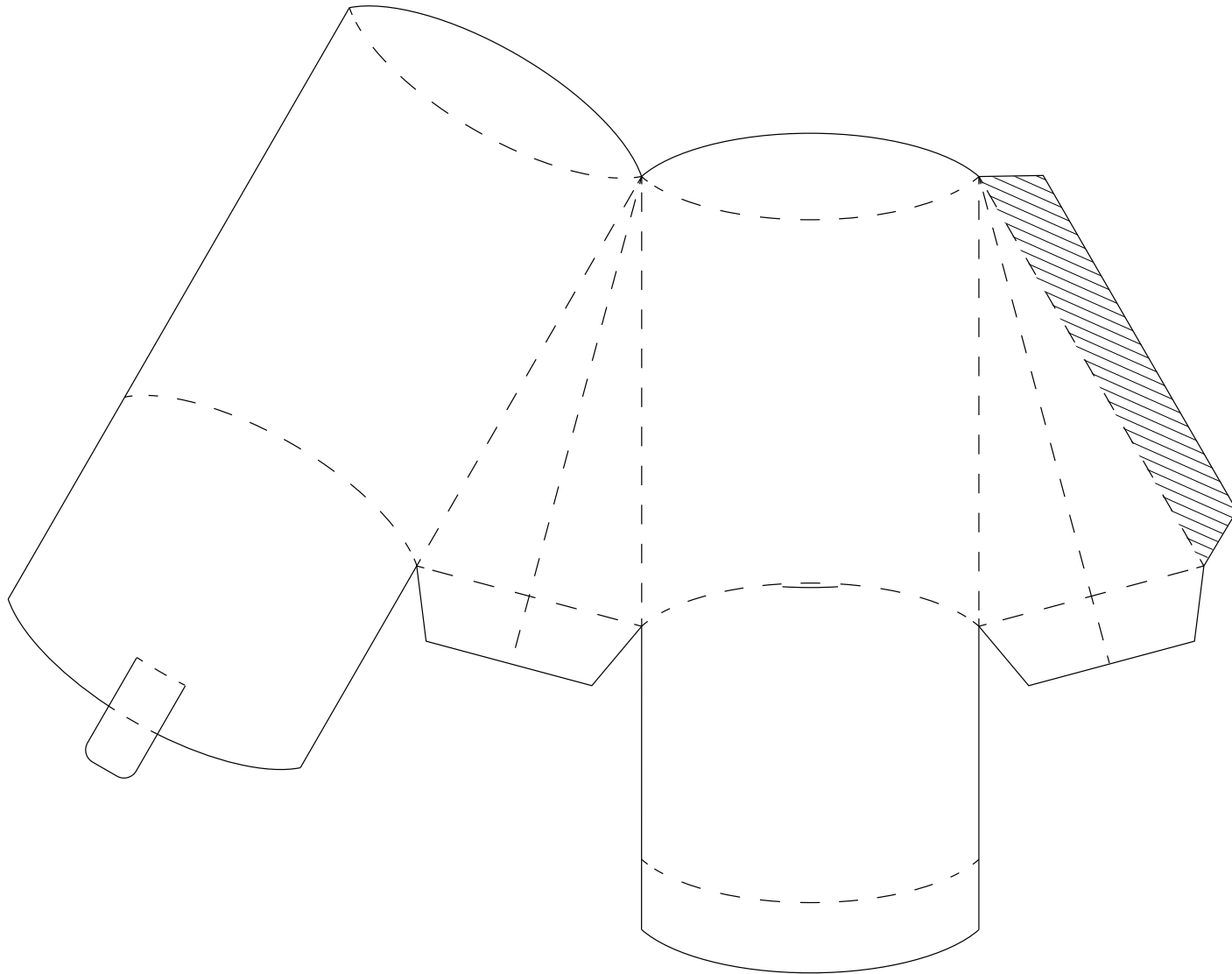



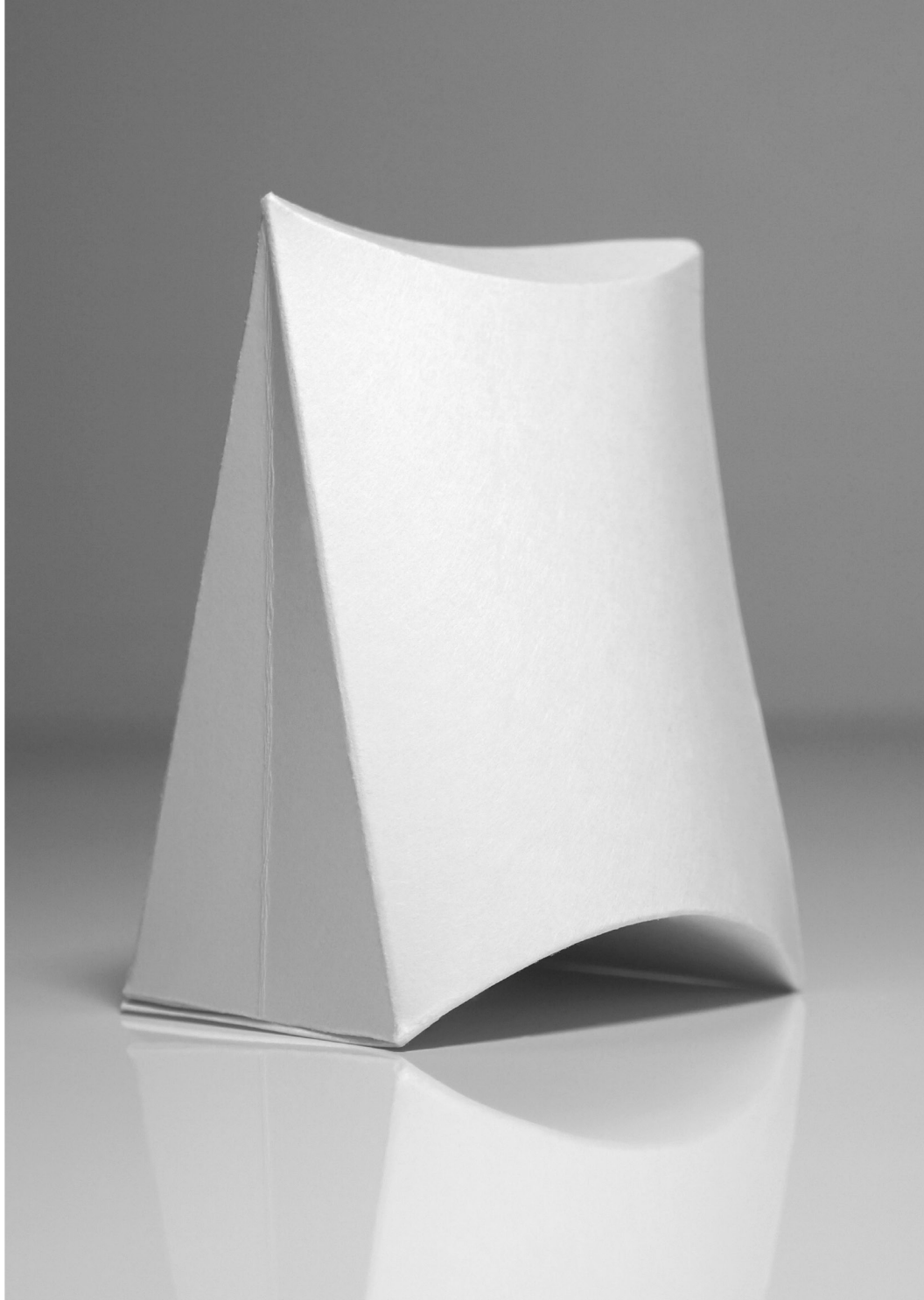
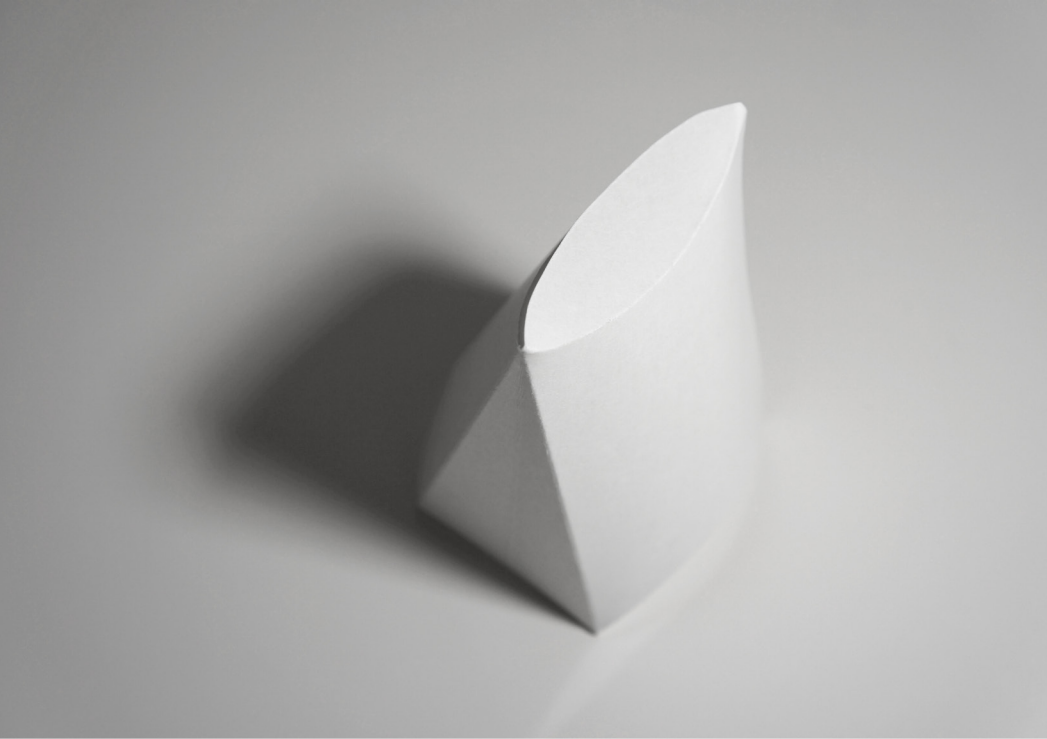

# CUT-AWAY PILLOW BOX

An alternative to the standard pillow box packaging design, the Cut-Away Pillow Box cuts an edge away to create a flat surface, allowing it to stand on its own. The box opens and closes in the same way as a normal pillow box.

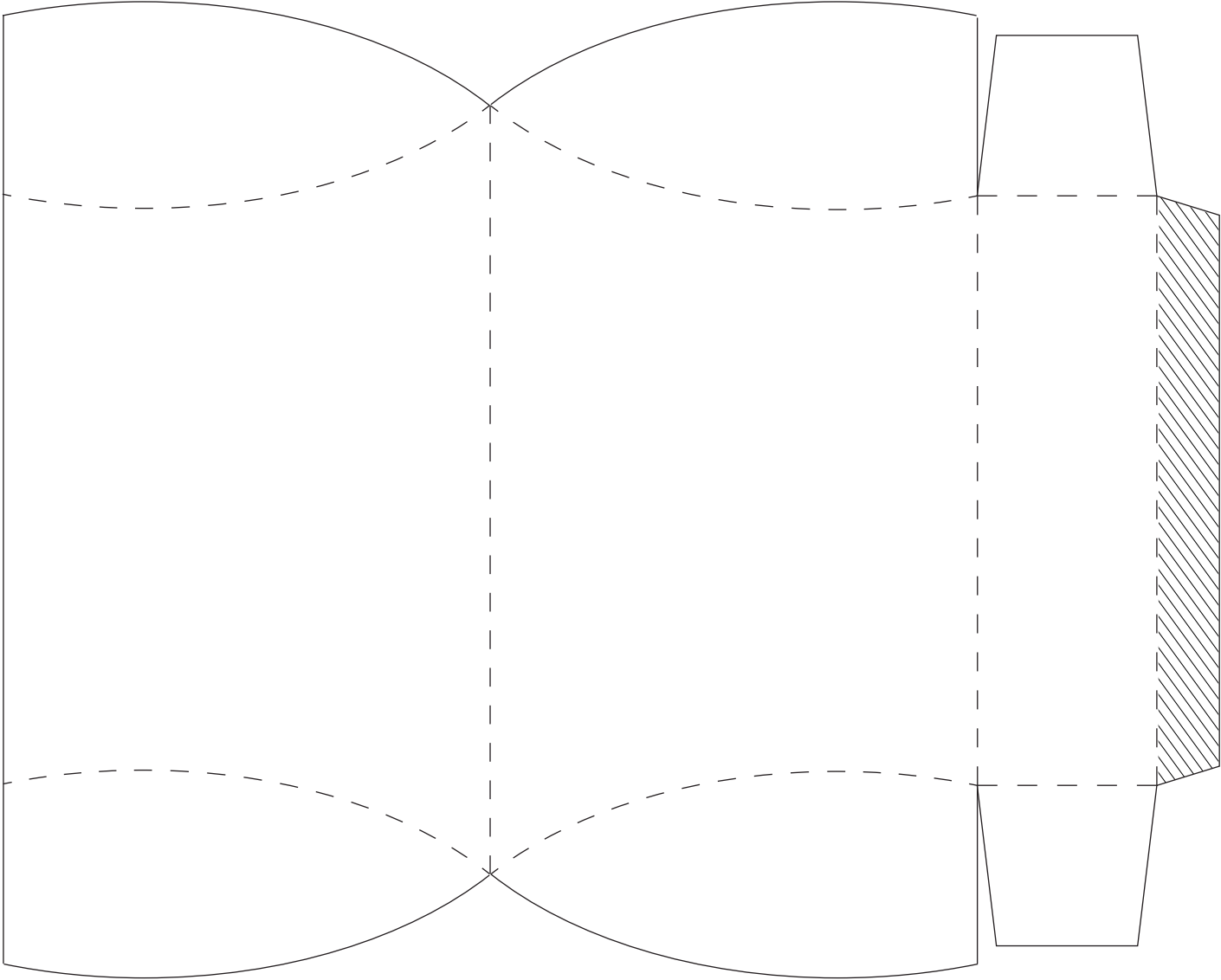

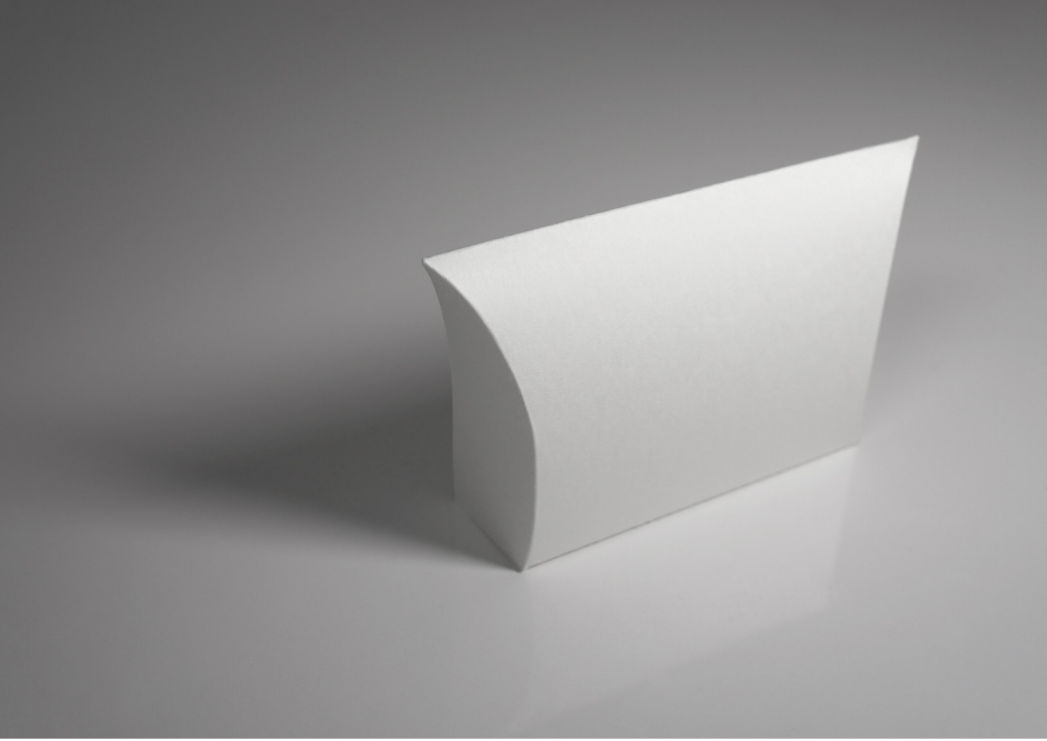

# STANDING PILLOW BOX

Pillow boxes fall flat compared to this Standing Pillow Box! This variation of the traditional packaging features a flat base and a hanging peg hole, allowing it to be presented in almost any retail situation.

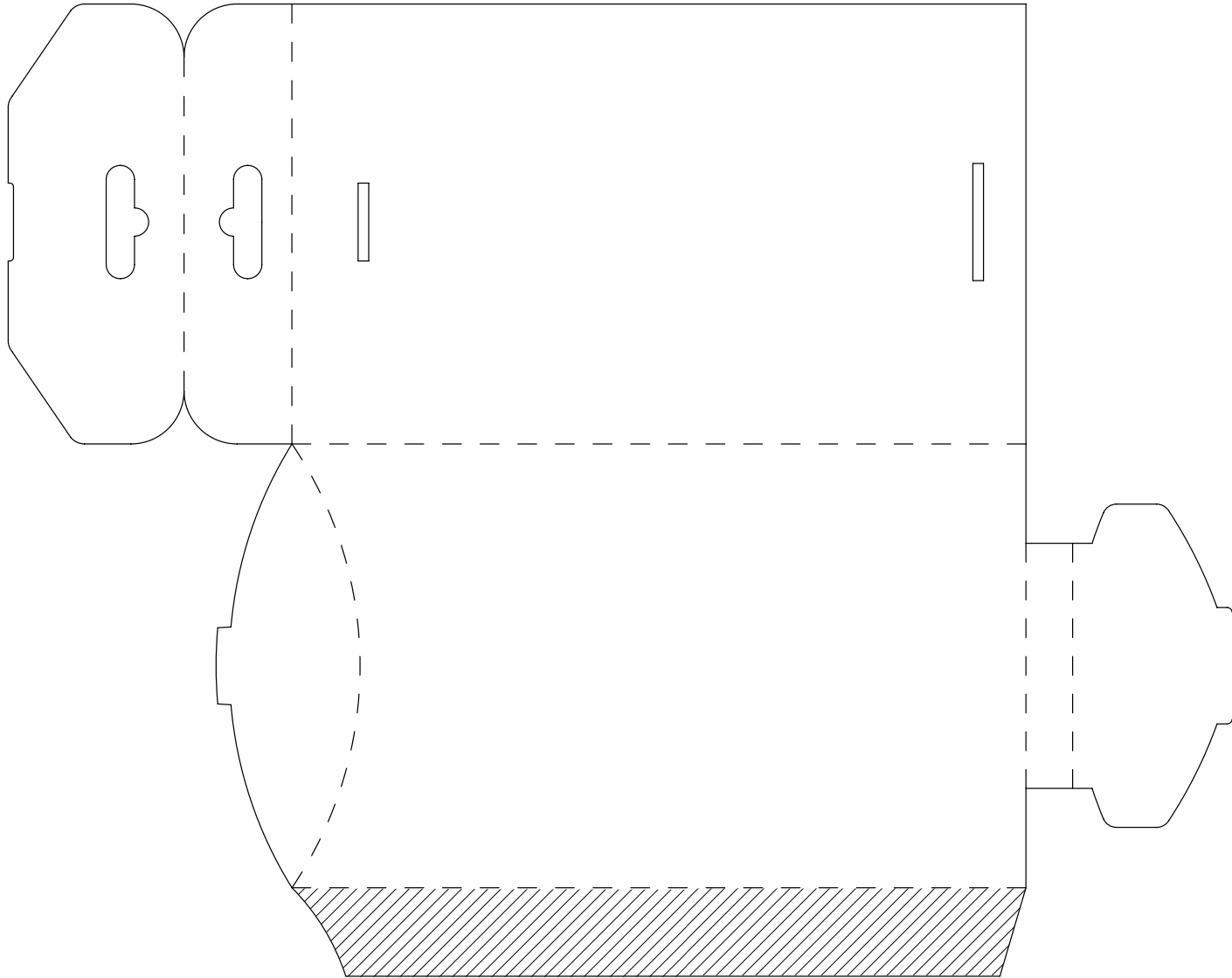

**MAT BOGUST**  
Guest Contributor

Cardboard Engineer  
at THINK Packaging,  
based in New Zealand.

w: [thinkpack.co.nz](http://thinkpack.co.nz)  
t: [@mat\\_bogust](https://twitter.com/mat_bogust)  
i: [@think\\_packaging](https://www.instagram.com/think_packaging)



# PENCIL BOX

Not your ordinary pencil box, this pencil-shaped packaging can be opened from either end, and is great for holding art supplies – or just pencils of course!

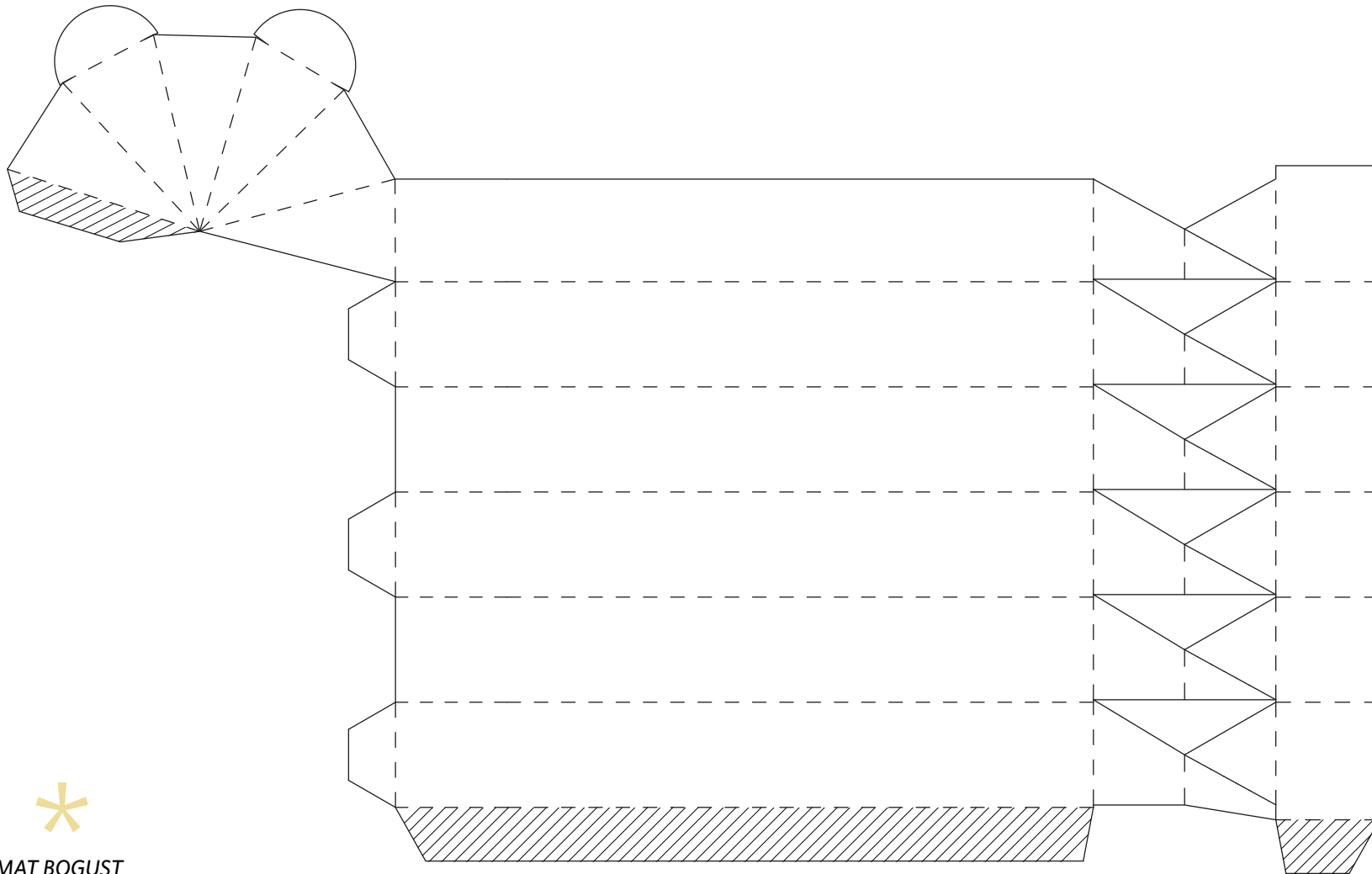

**MAT BOGUST**  
Guest Contributor

Cardboard Engineer  
at THINK Packaging,  
based in New Zealand.

w: [thinkpack.co.nz](http://thinkpack.co.nz)  
t: @mat\_bogust  
i: @think\_packaging

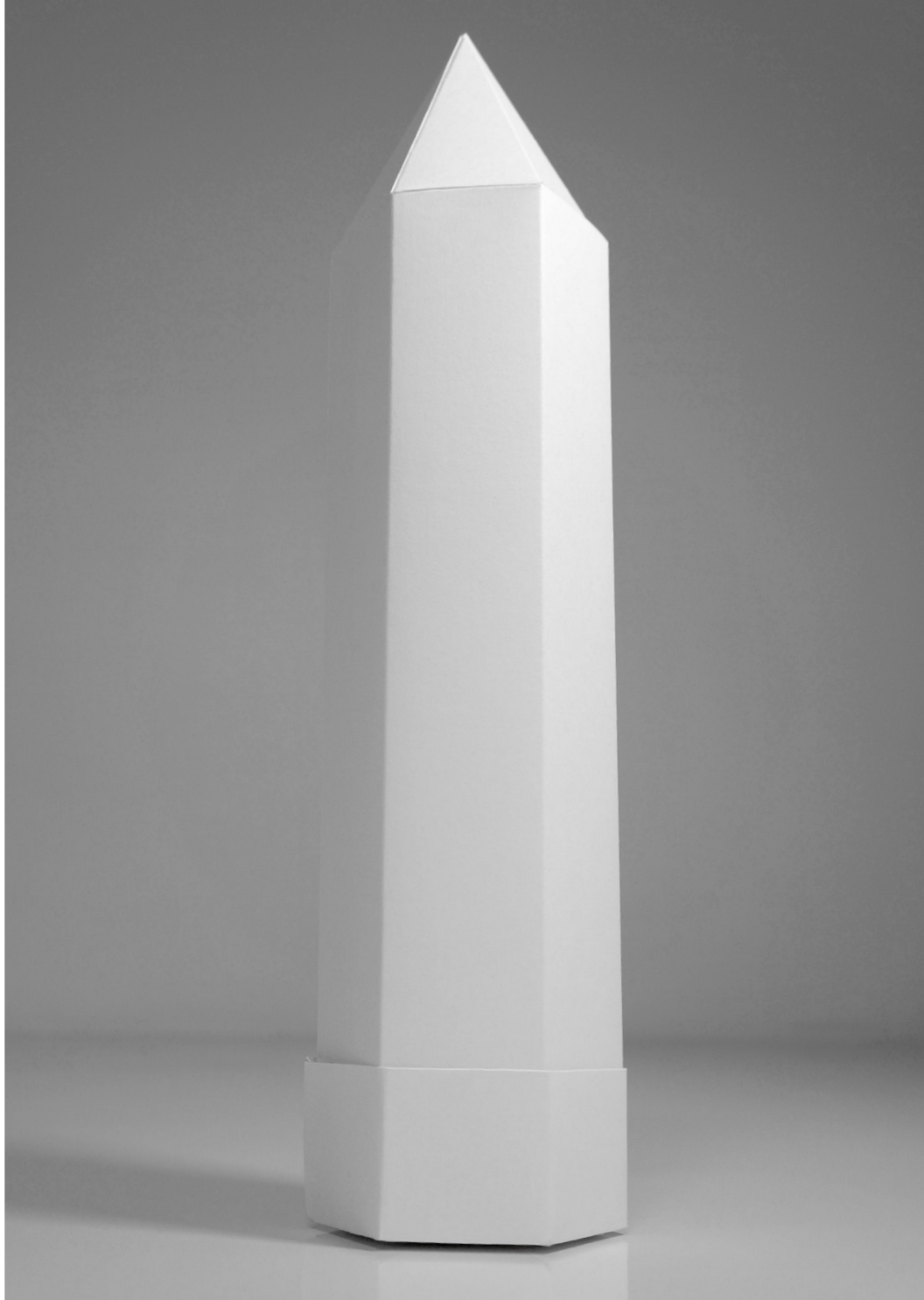
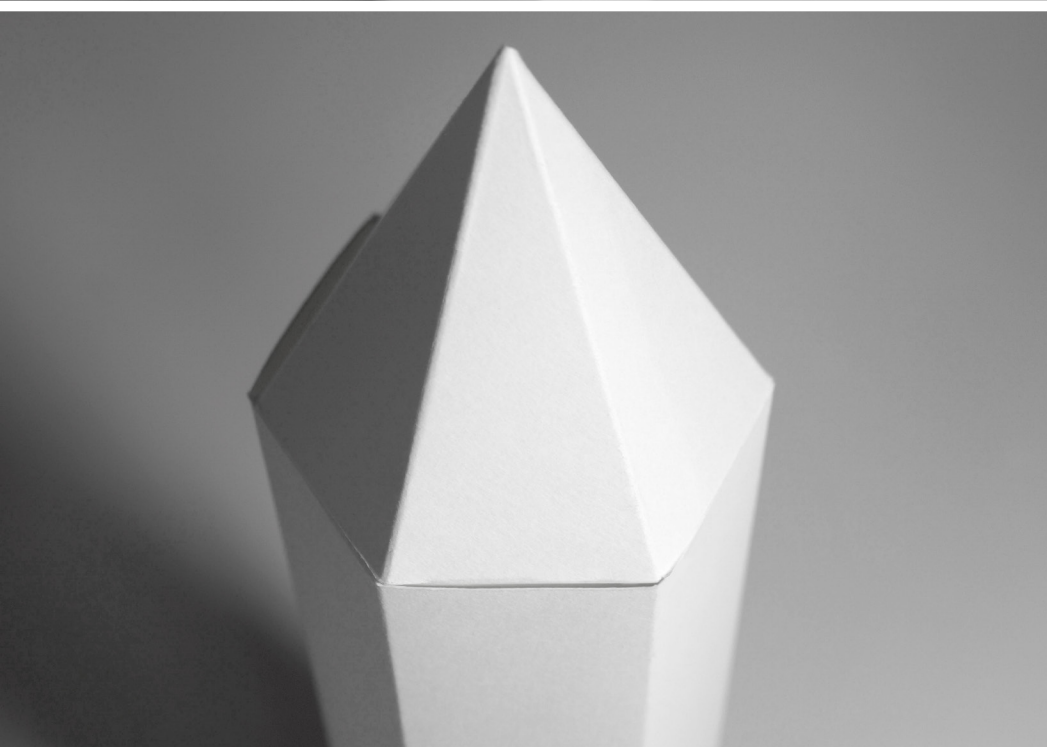
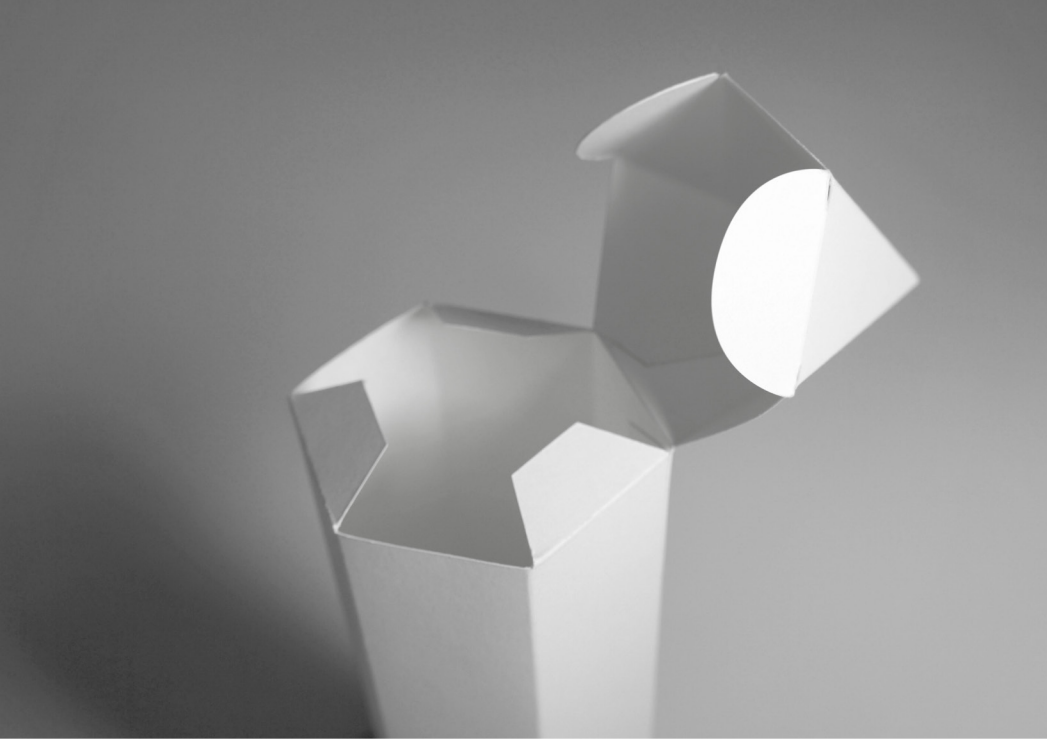

# SWIRLED POUCH

This small pouch conveys a strong sense of motion and energy while maintaining elegant curves and a floral-like locking pattern on top. The Swirled Pouch uses no glue, just the tensions of the folds.

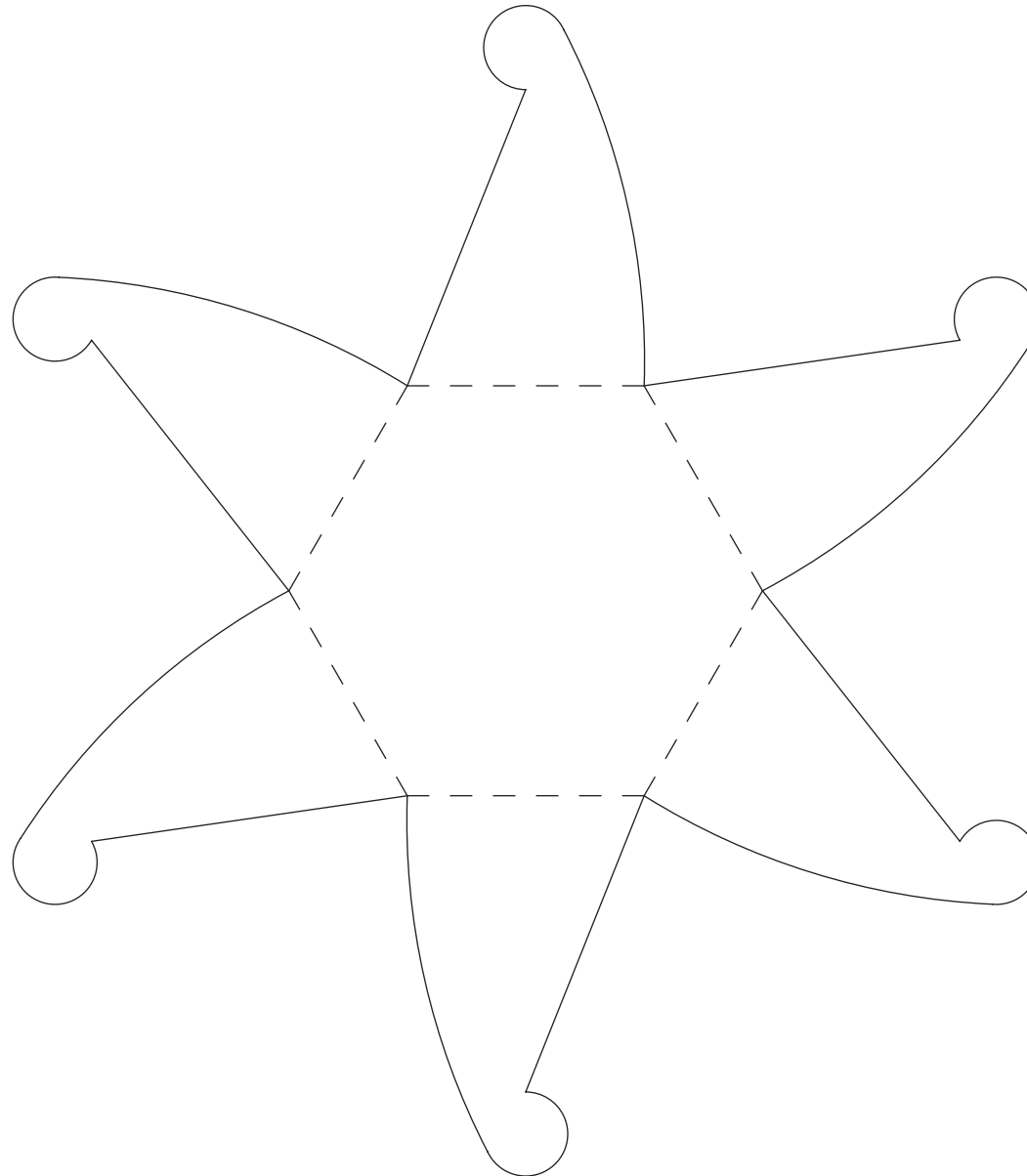

**MAT BOGUST**  
*Guest Contributor*

Cardboard Engineer  
at THINK Packaging,  
based in New Zealand.

w: [thinkpack.co.nz](http://thinkpack.co.nz)  
t: [@mat\\_bogust](https://twitter.com/mat_bogust)  
i: [@think\\_packaging](https://www.instagram.com/think_packaging)



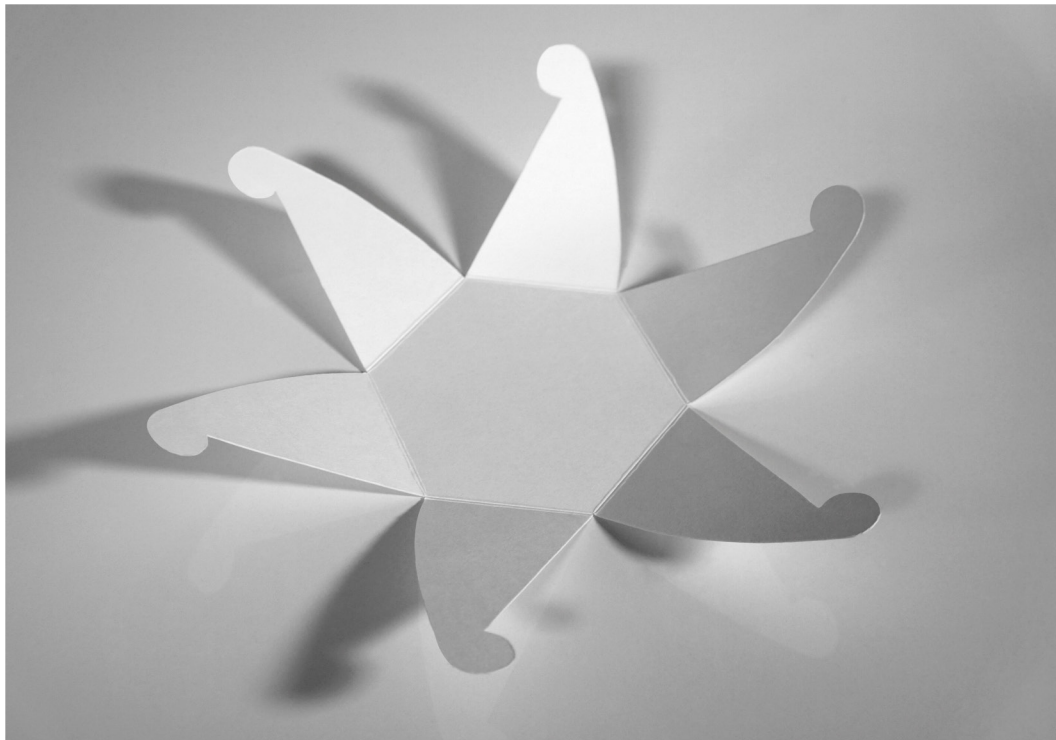
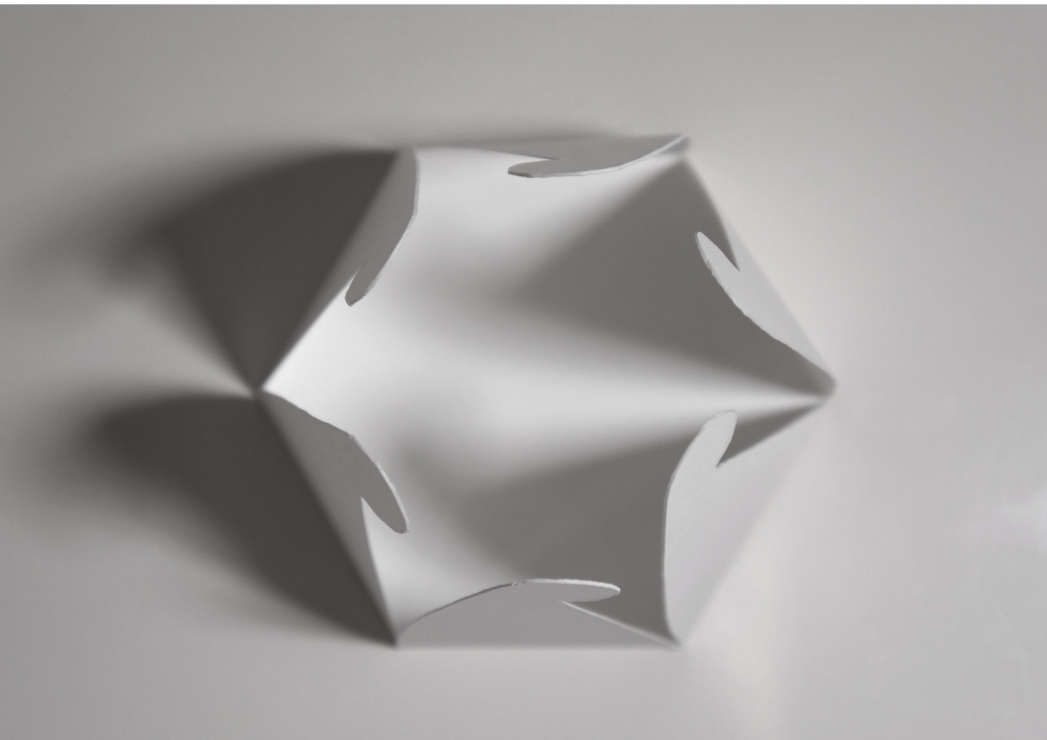
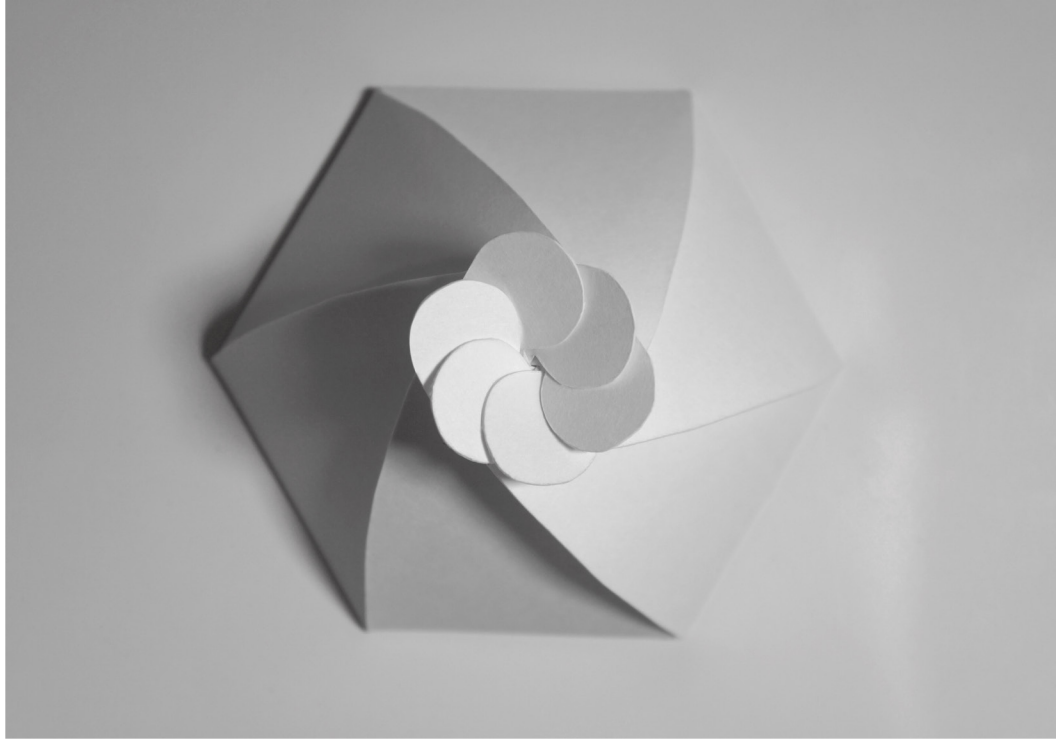
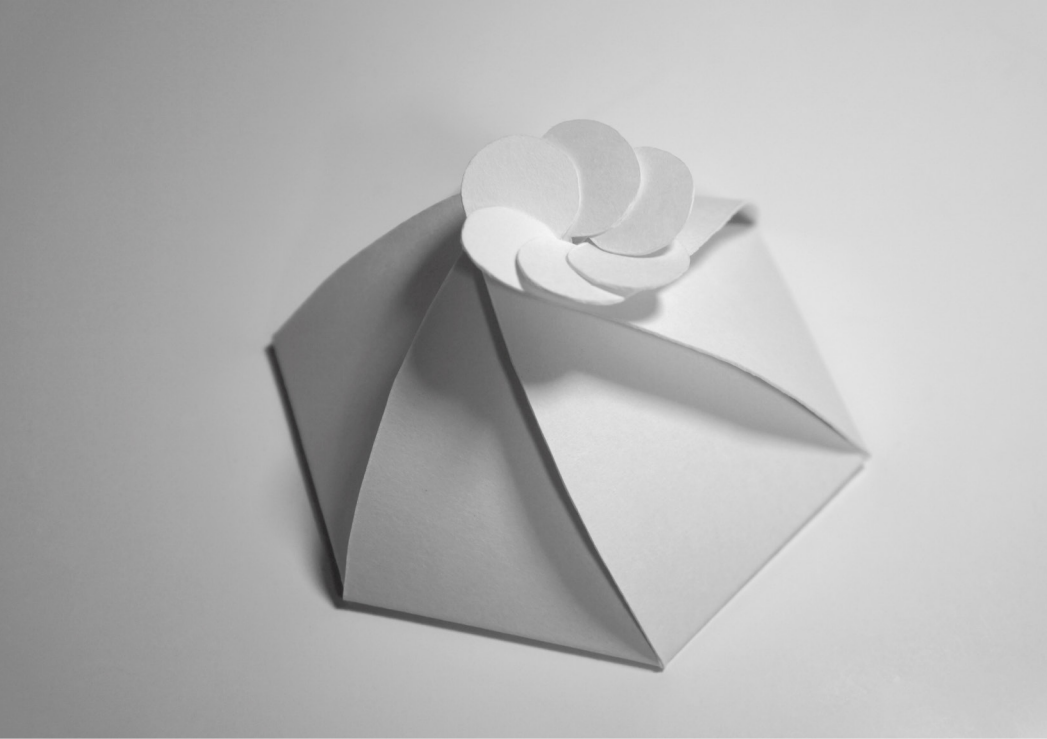

# BOOK BOX

This book-inspired box provides multiple areas to showcase product depending on your insert. Here, it's well suited for gift sets or membership and starter kits as they utilize the areas for cards and booklets.

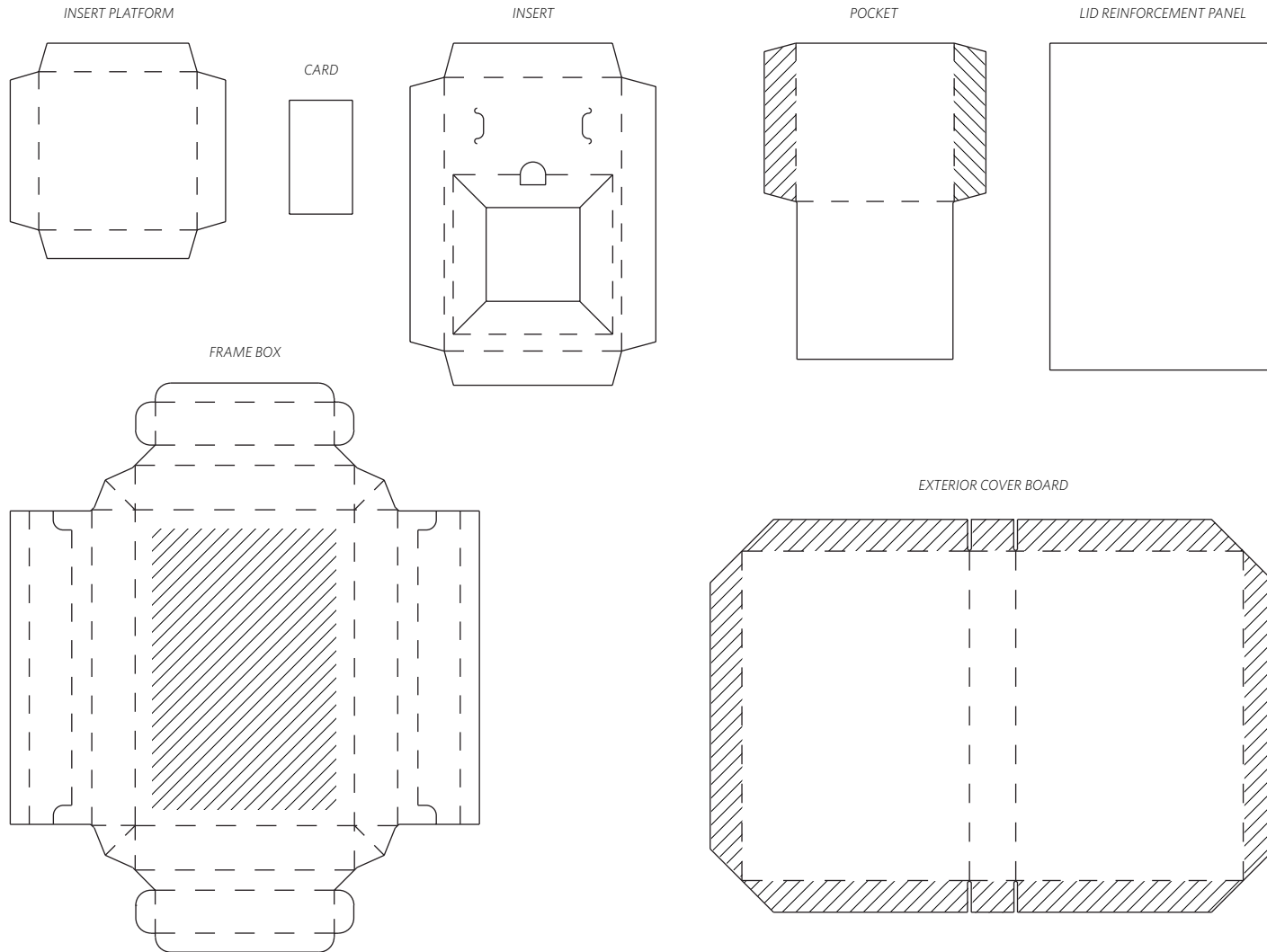

**MAT BOGUST**  
Guest Contributor

Cardboard Engineer  
at THINK Packaging,  
based in New Zealand.

w: [thinkpack.co.nz](http://thinkpack.co.nz)  
t: @mat\_bogust  
i: @think\_packaging

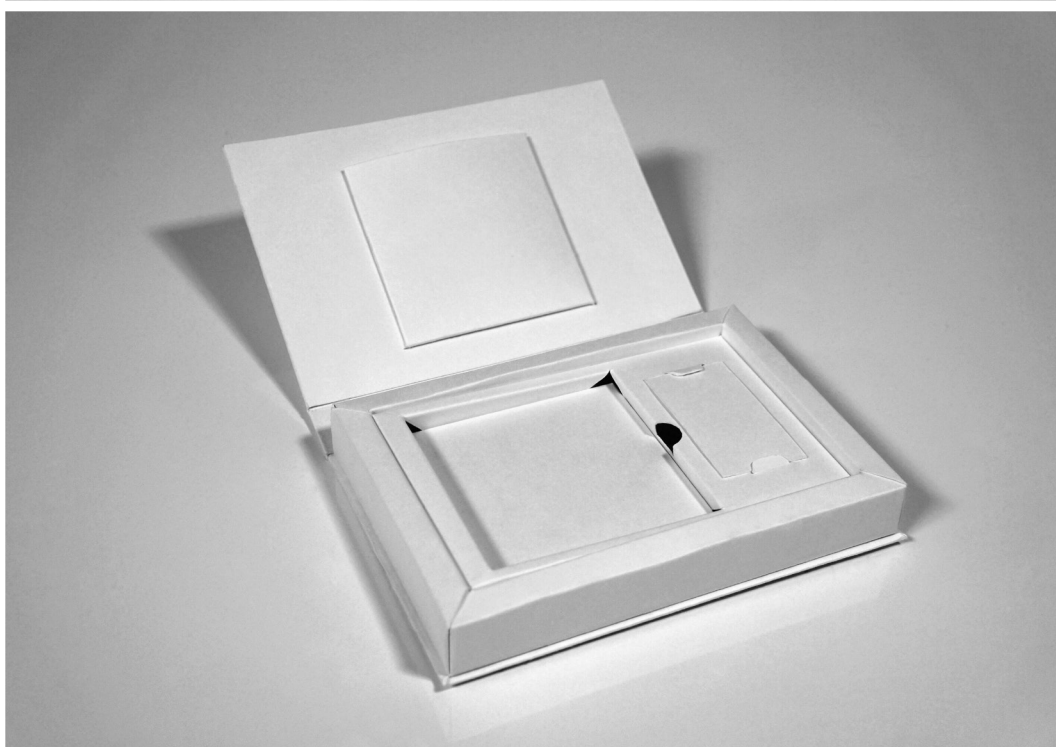
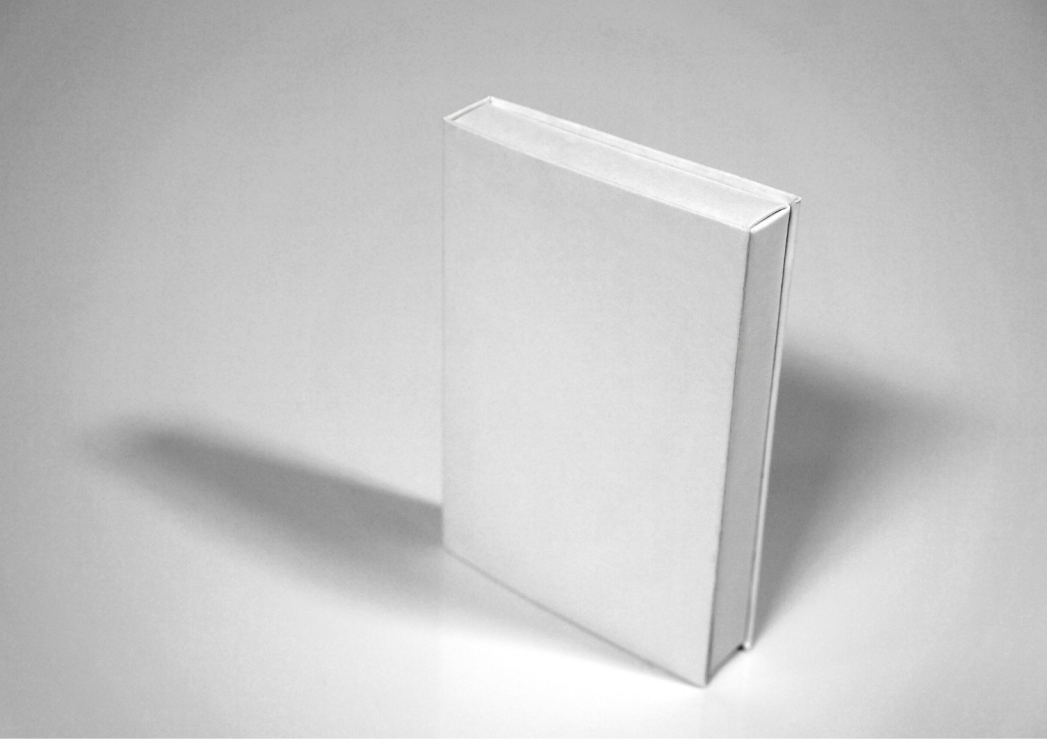

# BOX WITH SELF-SUPPORTING INSERT

This heavy-duty insert comes with its own built in supports allowing it to bear much more weight than a traditional folding insert. Hidden panels fold up for added strength.

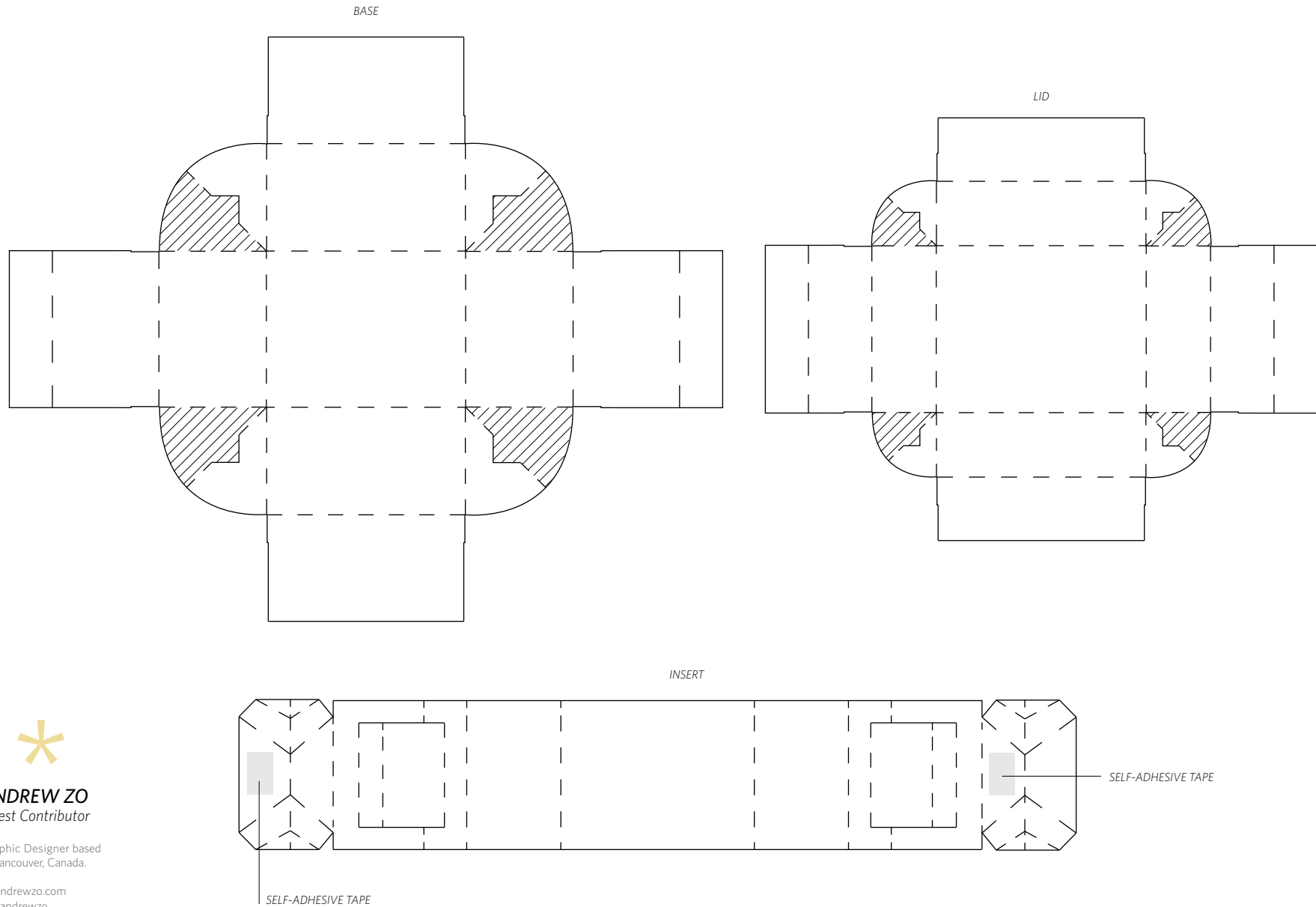

**ANDREW ZO**  
Guest Contributor

Graphic Designer based  
in Vancouver, Canada.

w: andrewzo.com  
t: @andrewzo

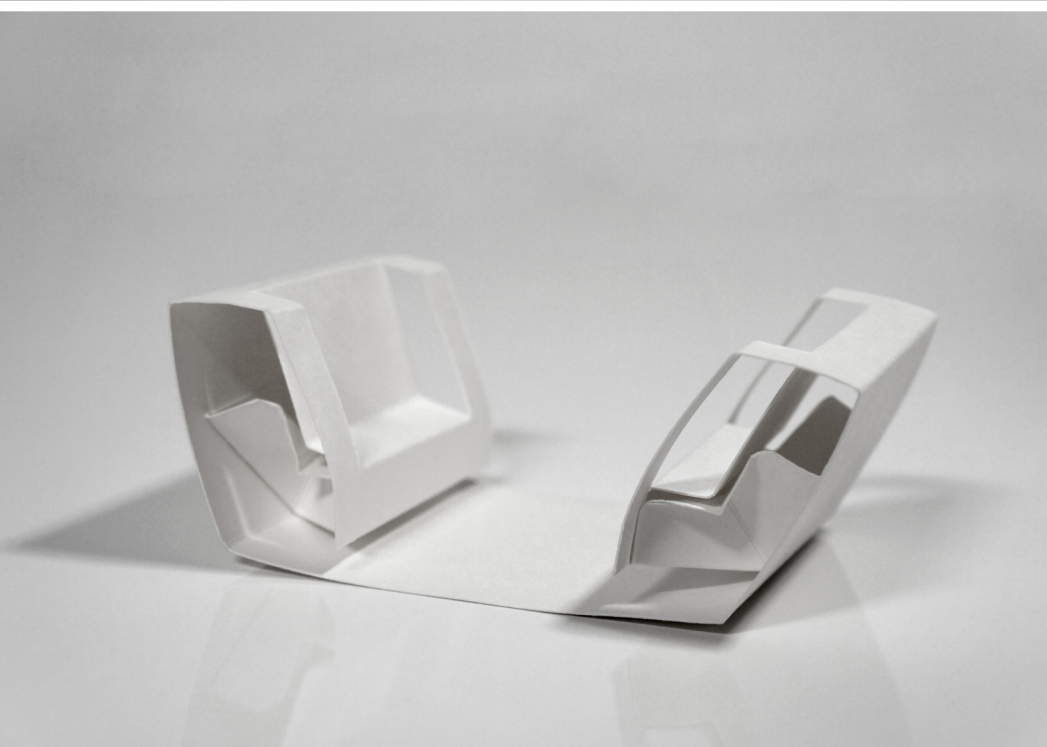
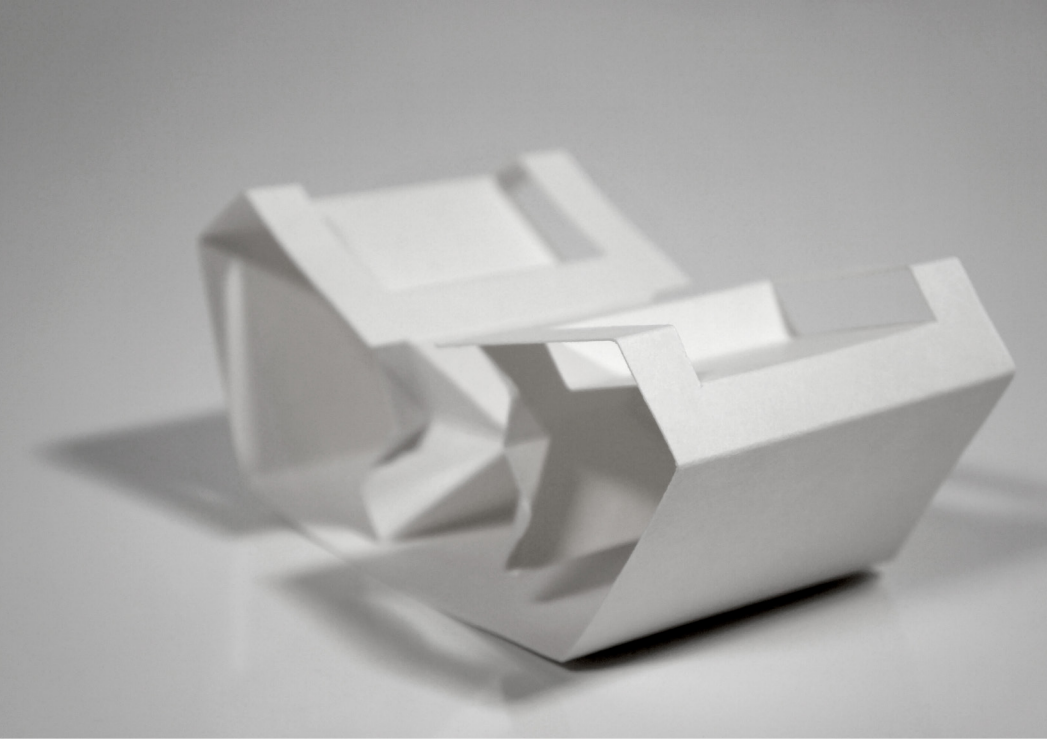

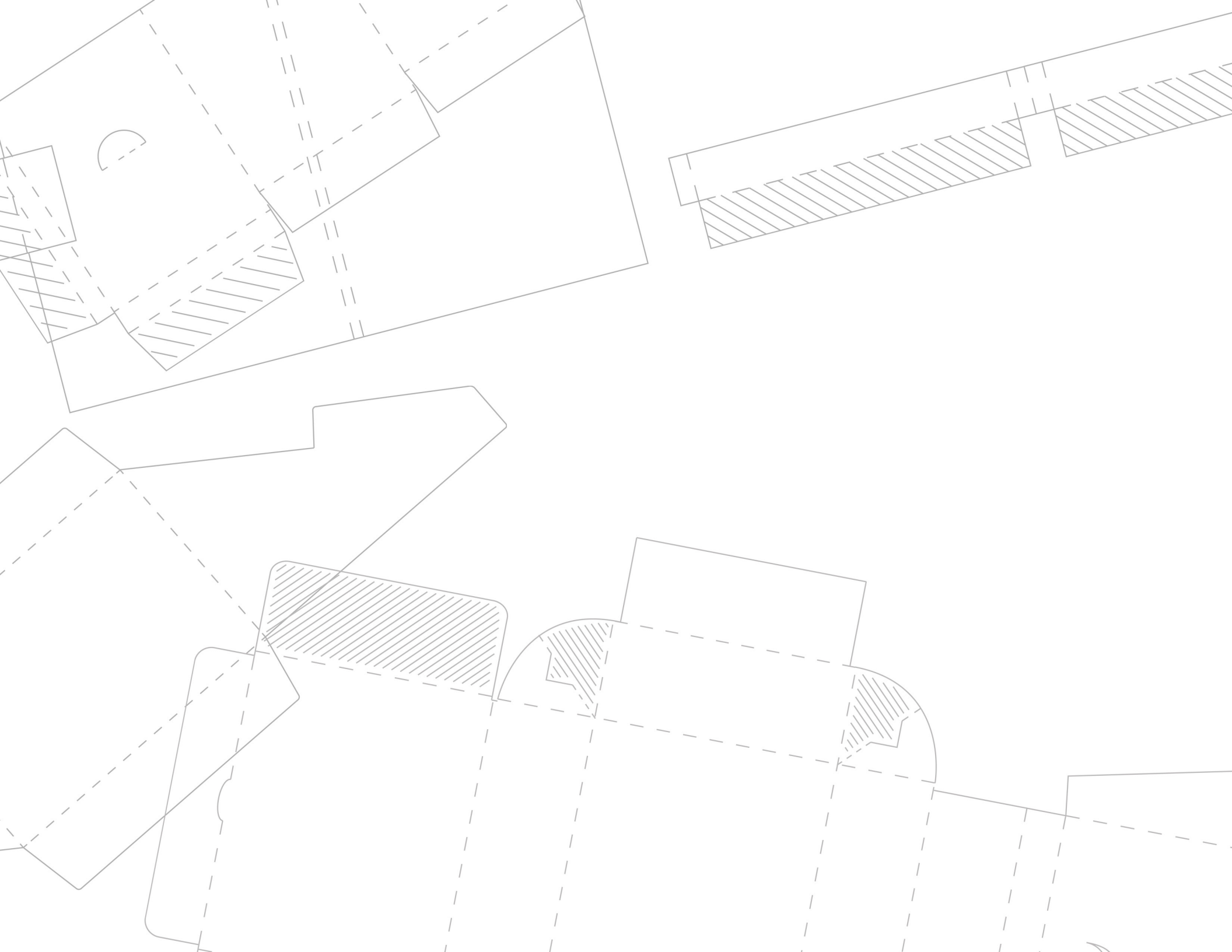



# GIFT CARD CARRIERS

Gift card carriers provide the gift aesthetic to relatively boring flat plastic cards. The balance between scale, unveiling, and material waste walks a fine line. The unveiling process of a gift card carrier has to meet three criteria: create anticipation upon receiving, provide adequate space for personalized messaging, and delay direct access to the gift card through a simple unveiling process. Meet these three criteria to create a memorable sense of value and thoughtfulness in the unboxing of gift card packaging. We recommend that you always print out the dielines to confirm dimensions, proportions, user experience, and that the structure is what you envisioned prior to applying artwork.

# TIERED GIFT CARD CARRIER

The Tiered Gift Card Carrier uses interior platforms to stagger the gift cards in a vertical, layered cascade. The flap is hinged closed by a simple diecut notch on the front pocket.

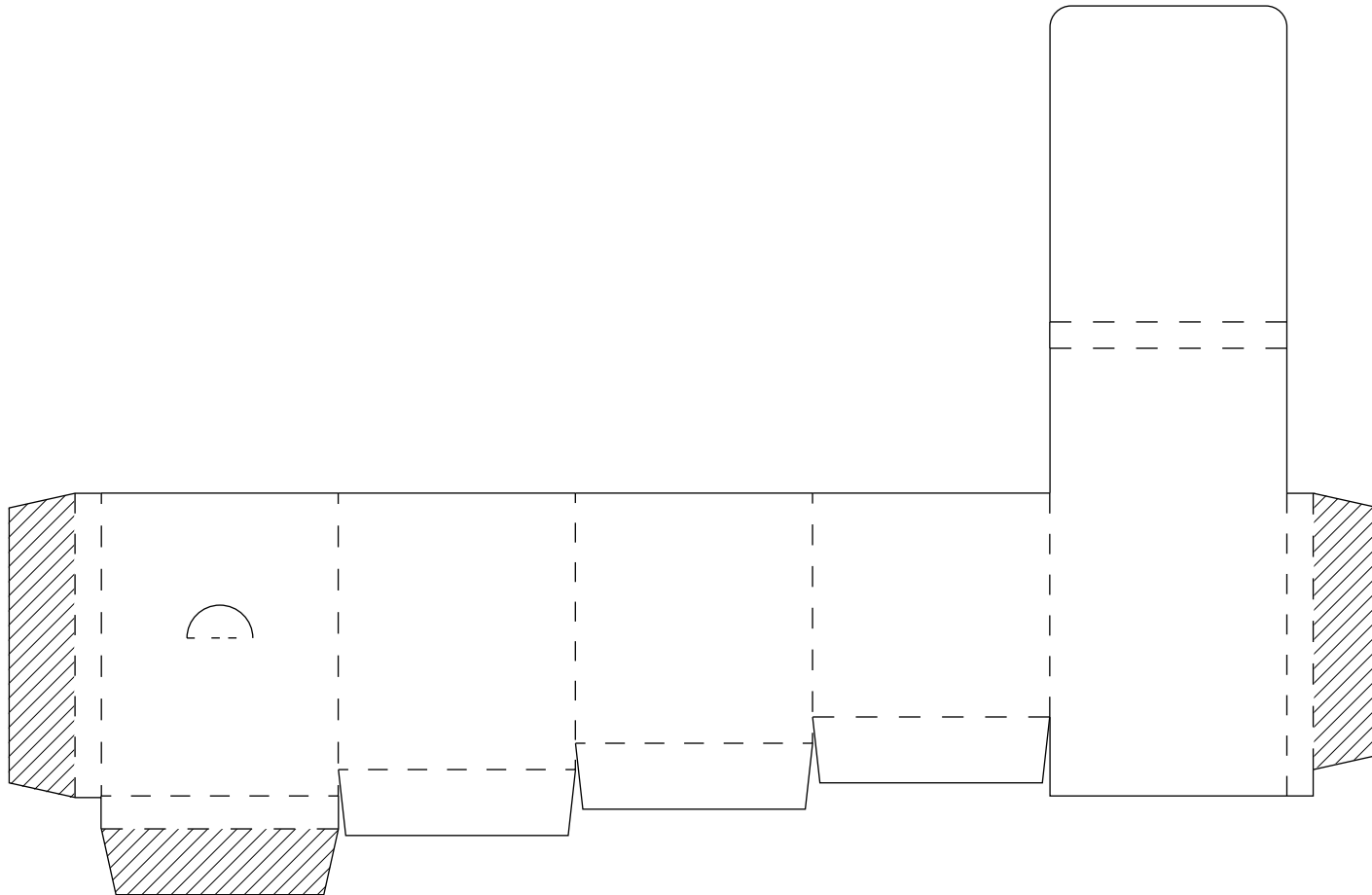



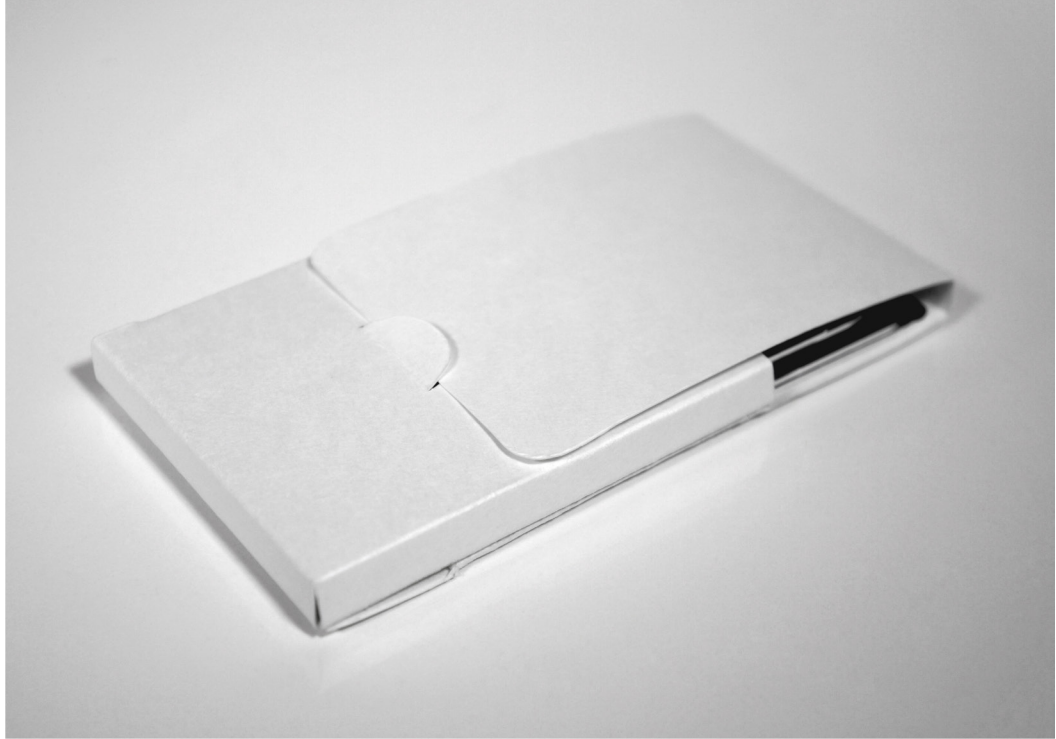

# POP-UP GIFT CARD CARRIER

The Pop-Up Gift Card Carrier surprises the viewer with a card that presents itself as the packaging design is opened. Creating this vertical presentation, puts it directly into the viewer's line of sight.

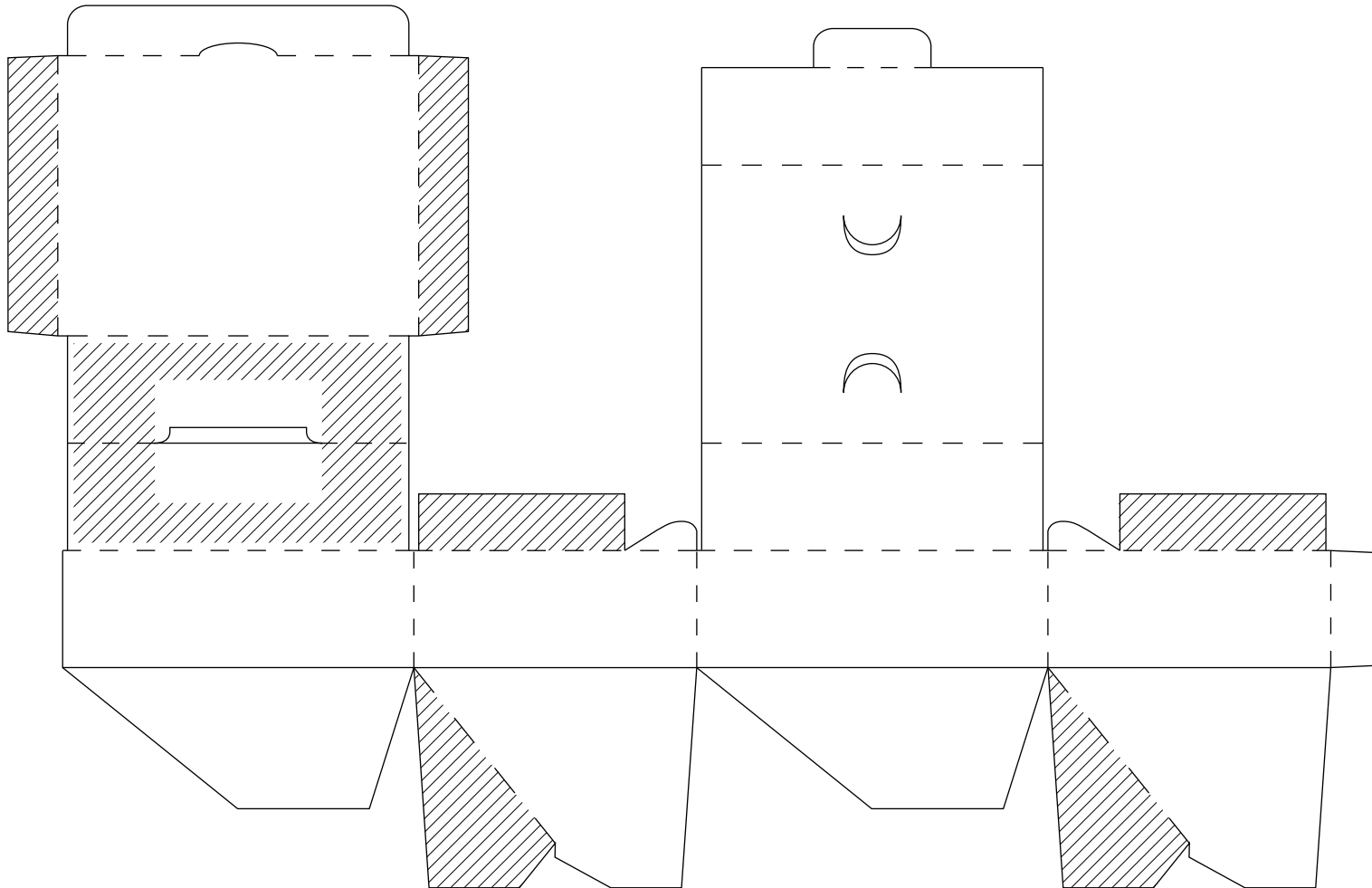

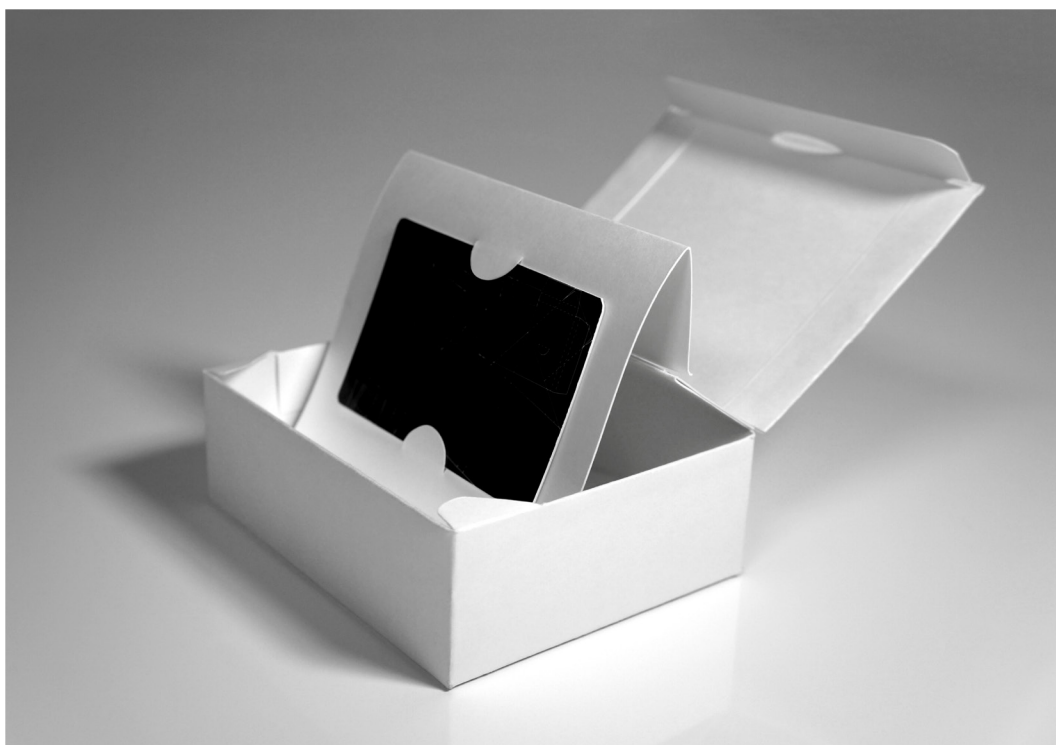
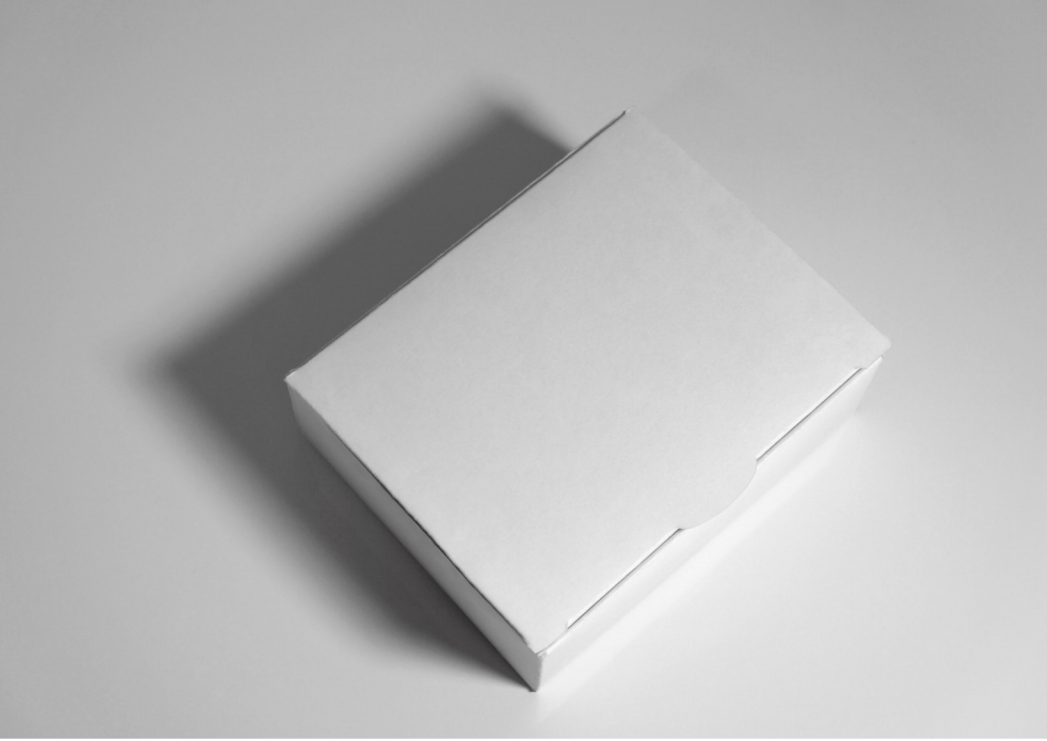

# POP-UP ENVELOPE

Everybody loves a pop-up! This interactive pop-up gift card carrier slowly presents the card from within the envelope as it opens, creating a dramatic unveiling allowing the card to be the centerpiece.

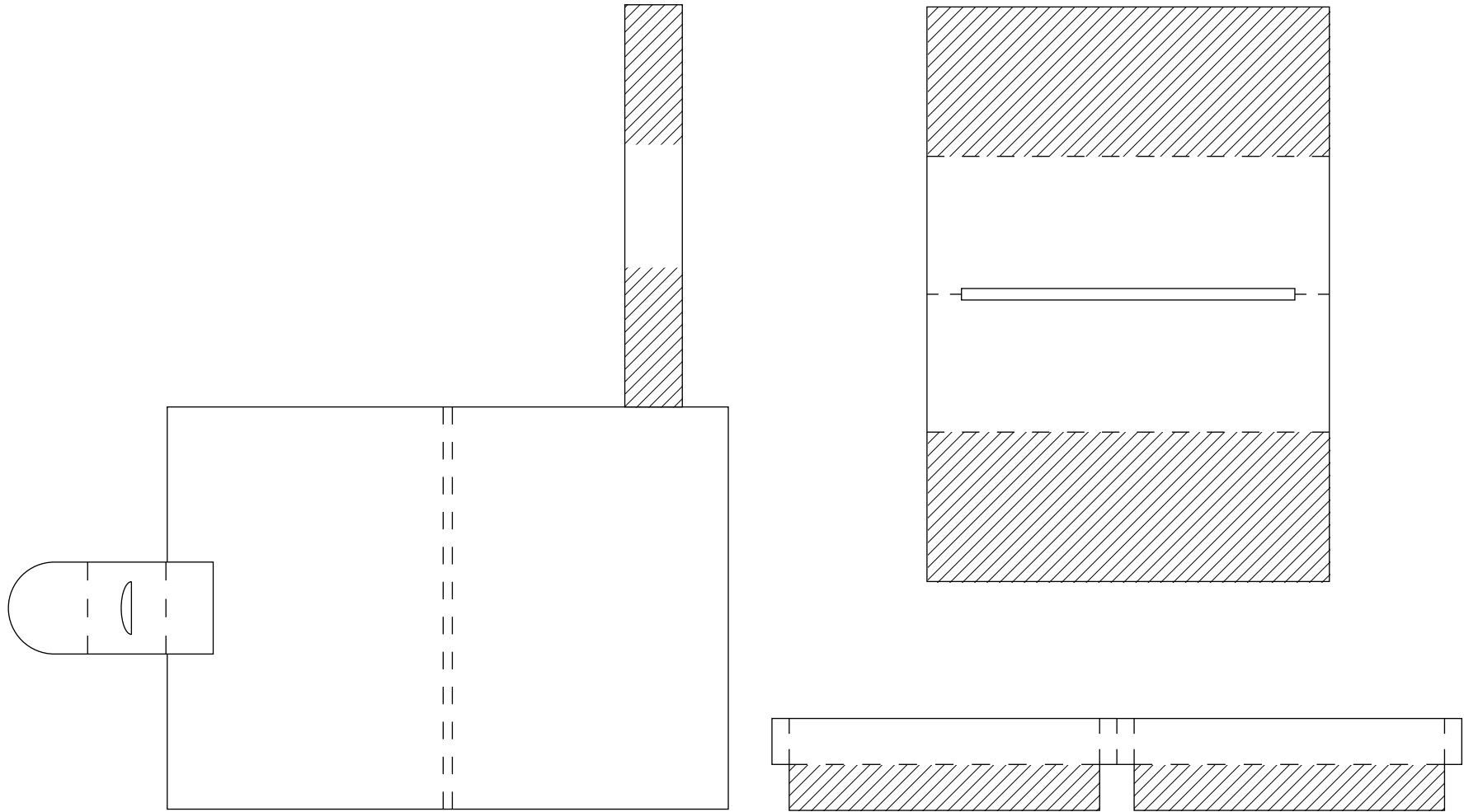

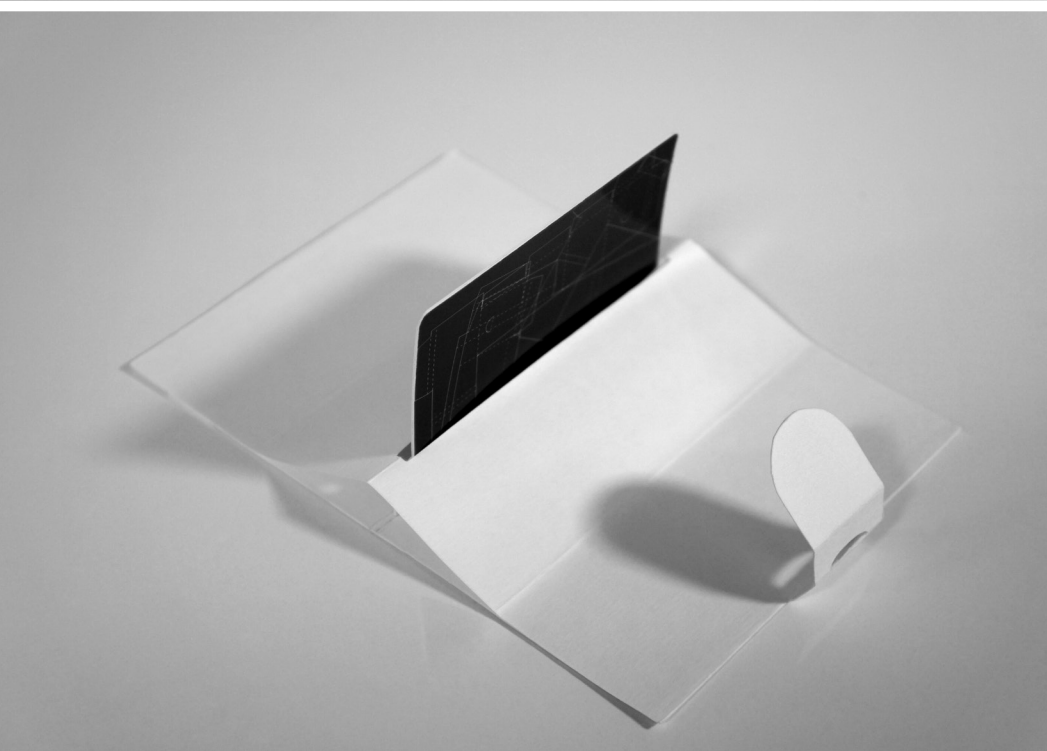
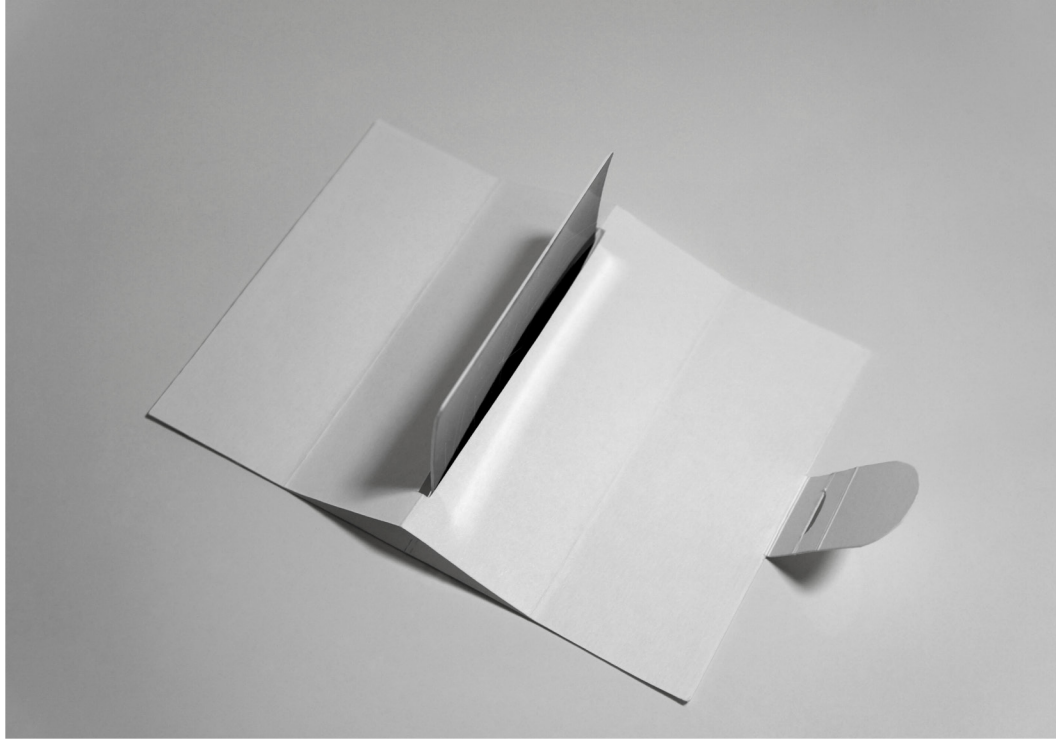
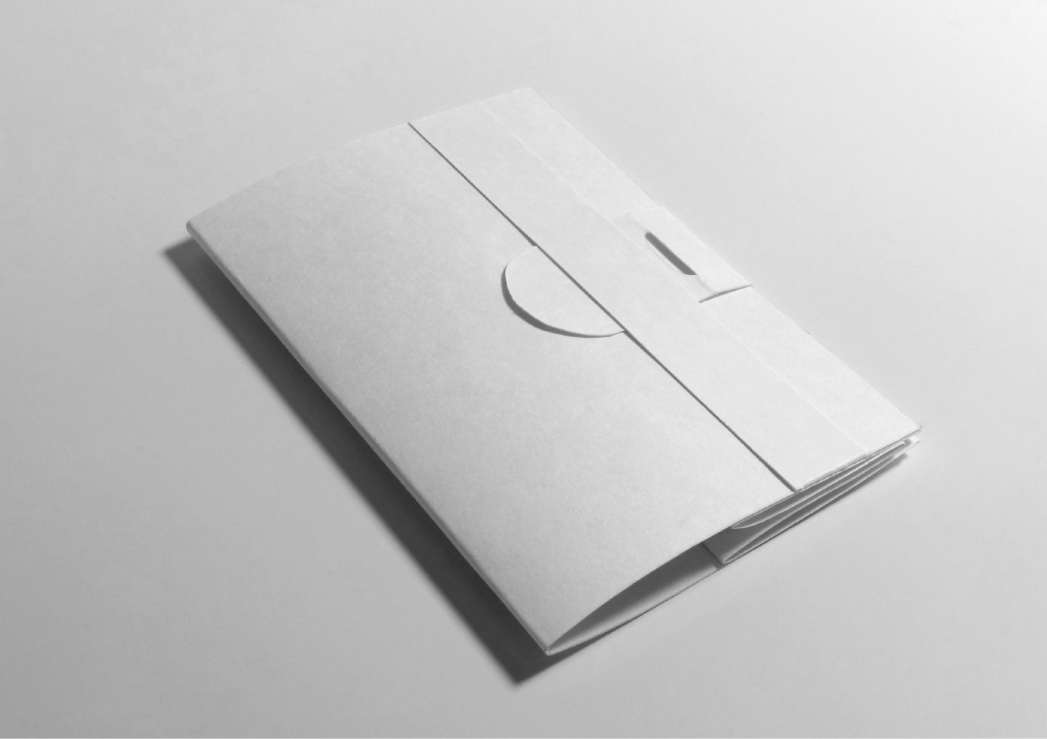

# SIMPLEX GIFT CARD CARRIER

This simplex style gift card carrier box includes a built-in insert that conveniently displays the gift card at an angle. The dieline can be adapted to fit a variety of products.

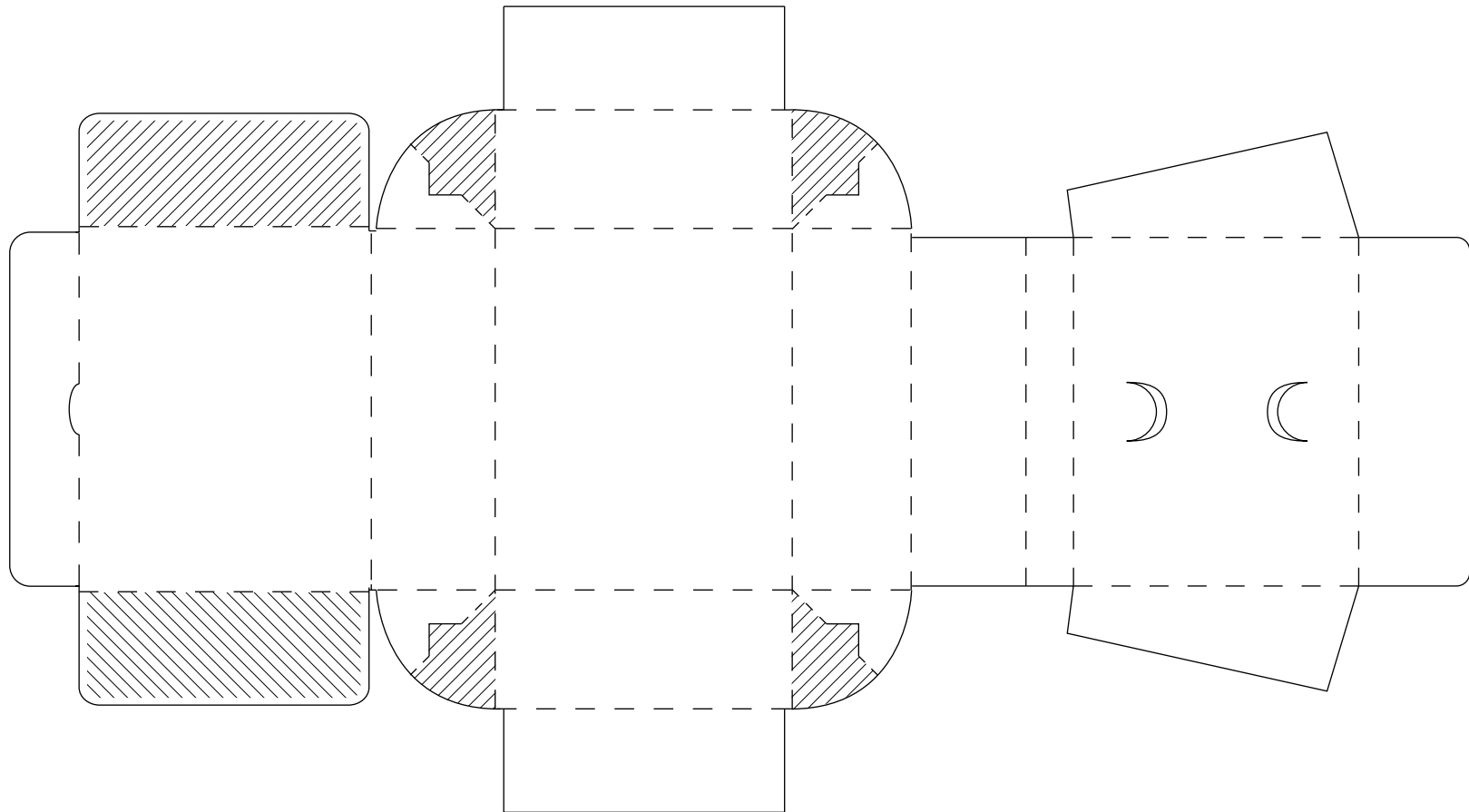



# INTERLOCKING ENVELOPE

The interlocking envelope uses no glue, utilizing a simple dieline with dramatic angles.

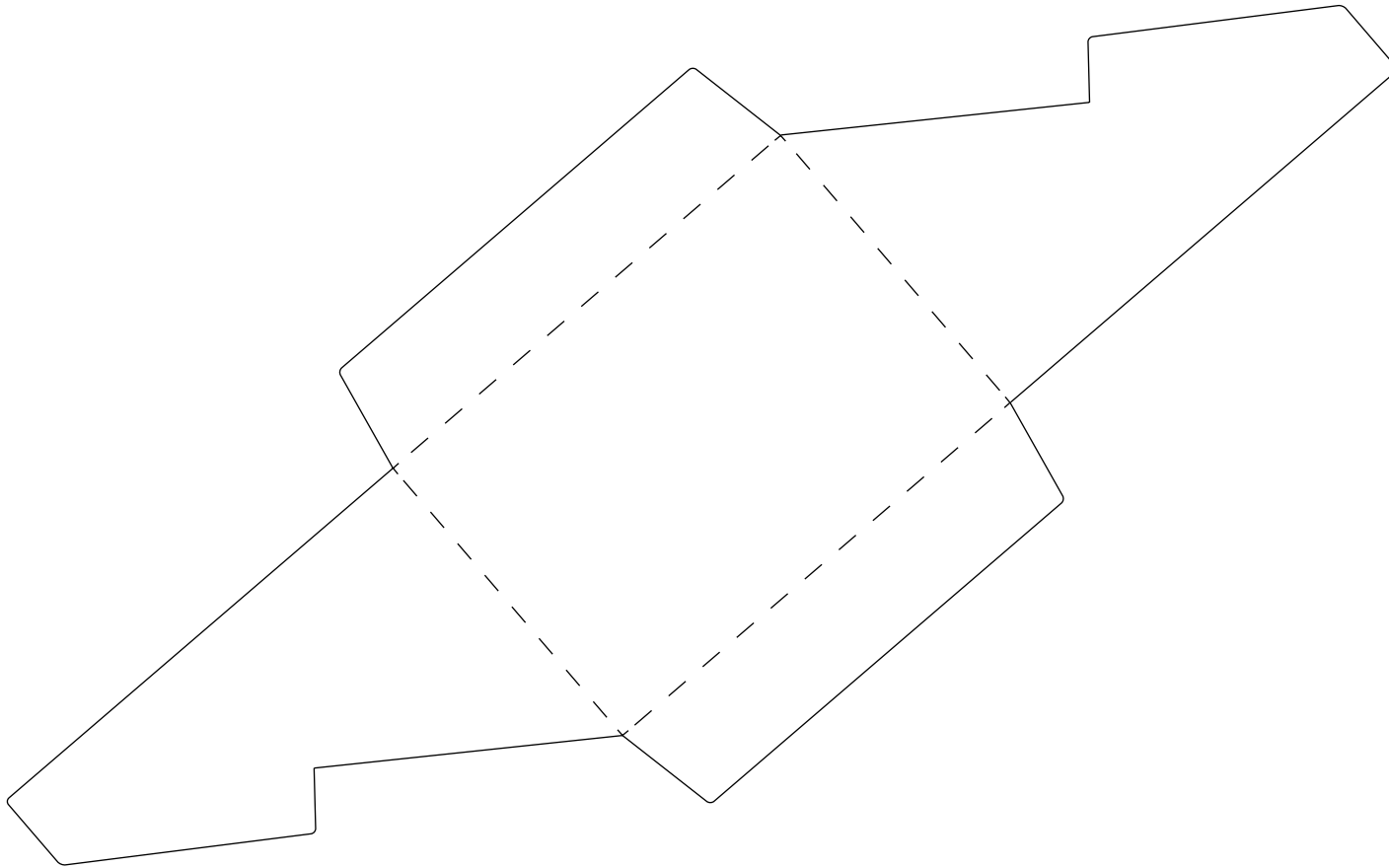

**ANDREW ZO**  
*Guest Contributor*

Graphic Designer based  
in Vancouver, Canada.

w: [andrewzo.com](http://andrewzo.com)  
t: [@andrewzo](https://twitter.com/andrewzo)



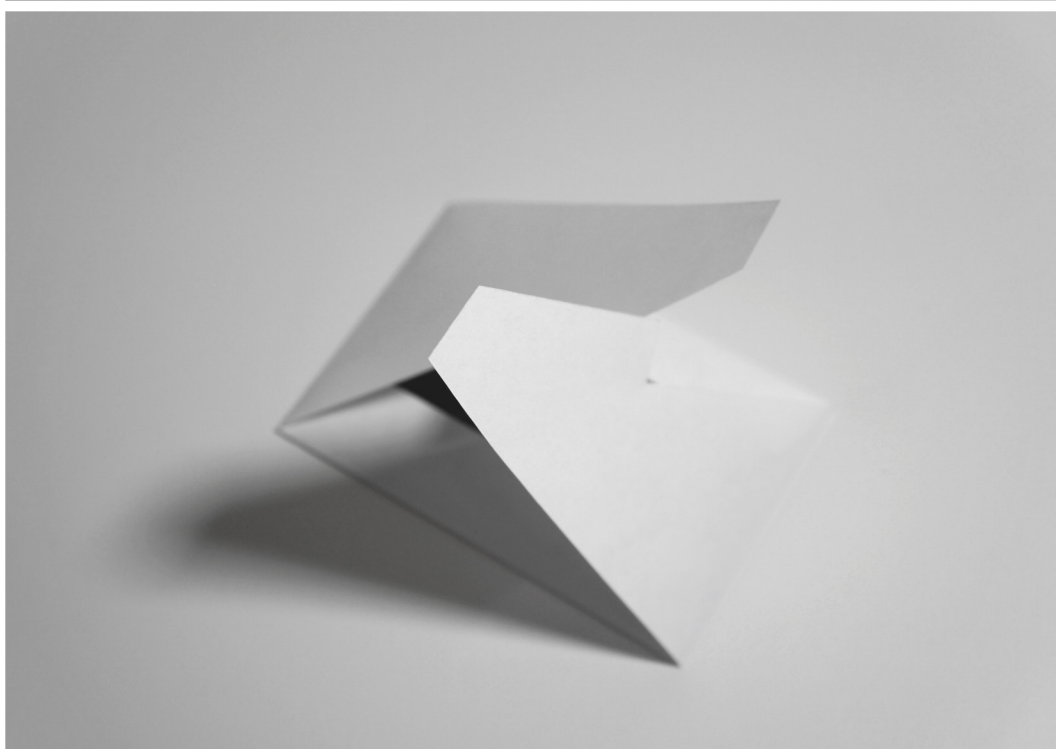
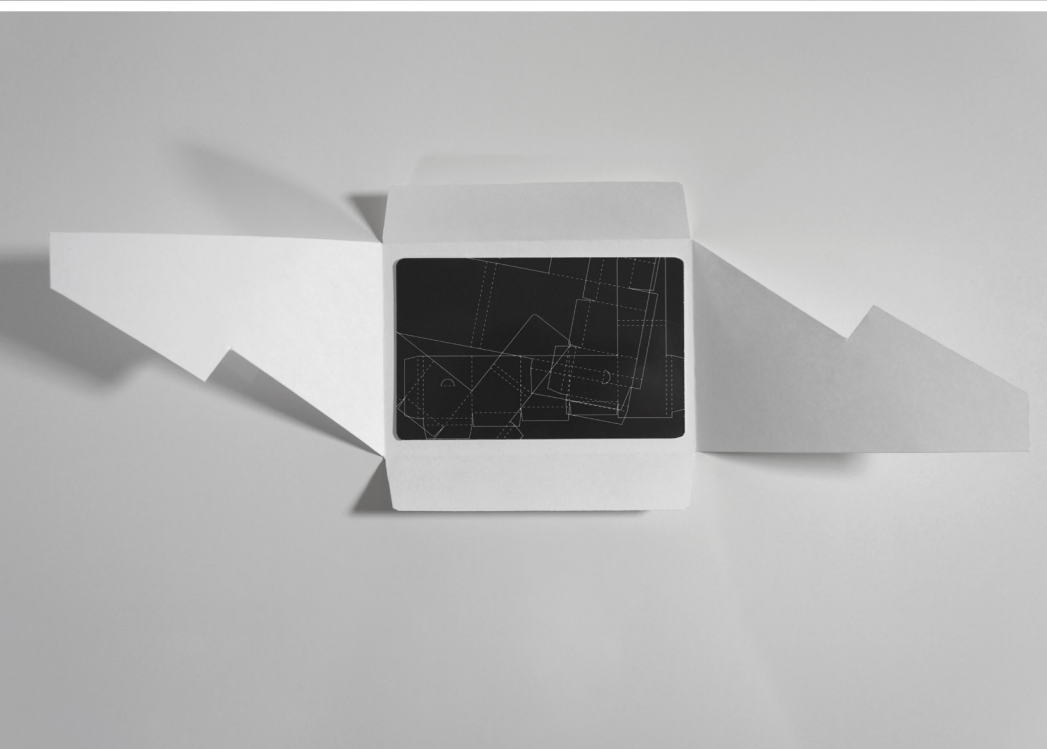
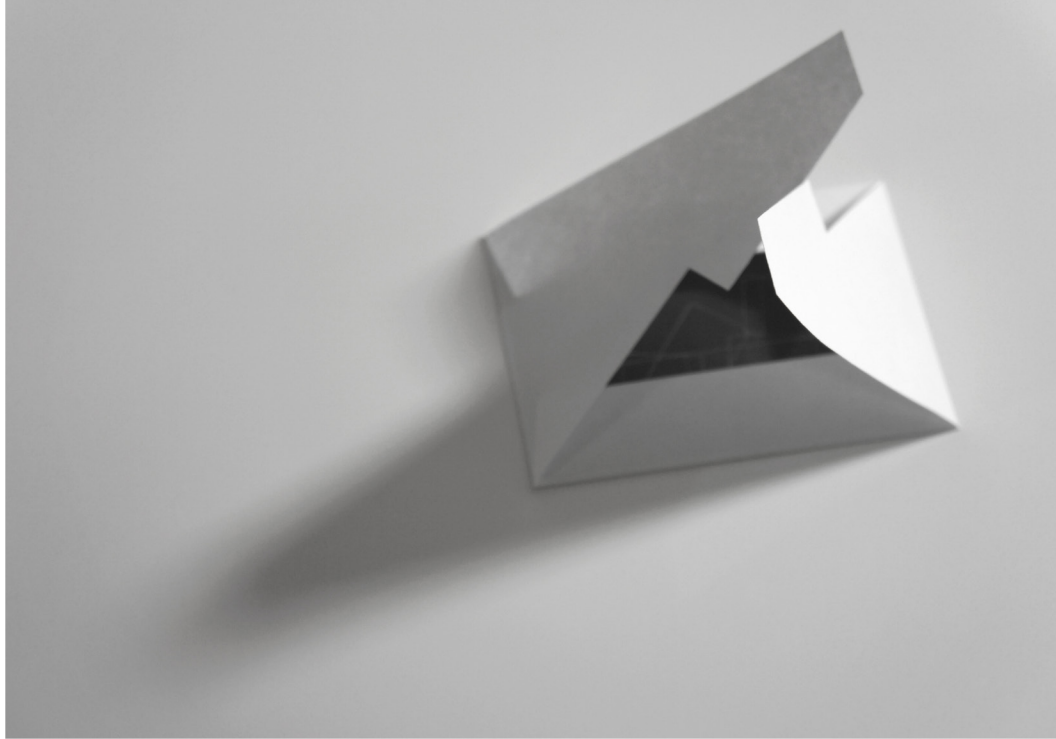
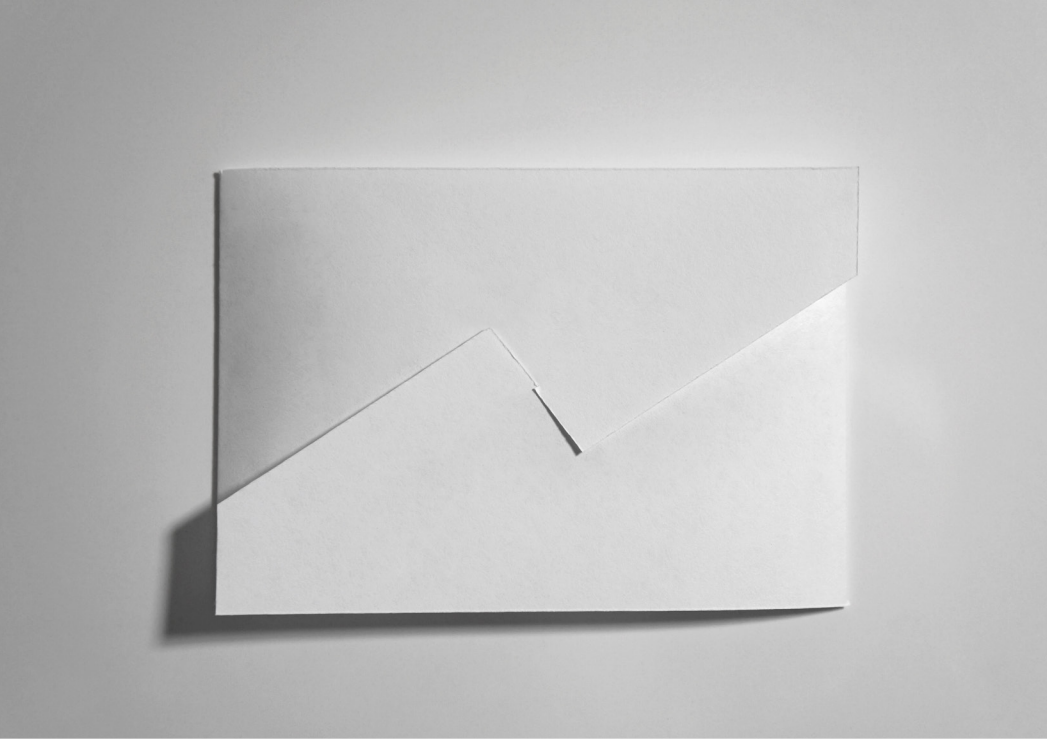

# ORIGAMI ENVELOPE

Inspired by the art of folding paper, this card holder turns a flat sheet of paper into a compact little envelope. This is a great option when a standard envelope just won't do. Holds together with a wafer seal or peel and stick on the reverse.

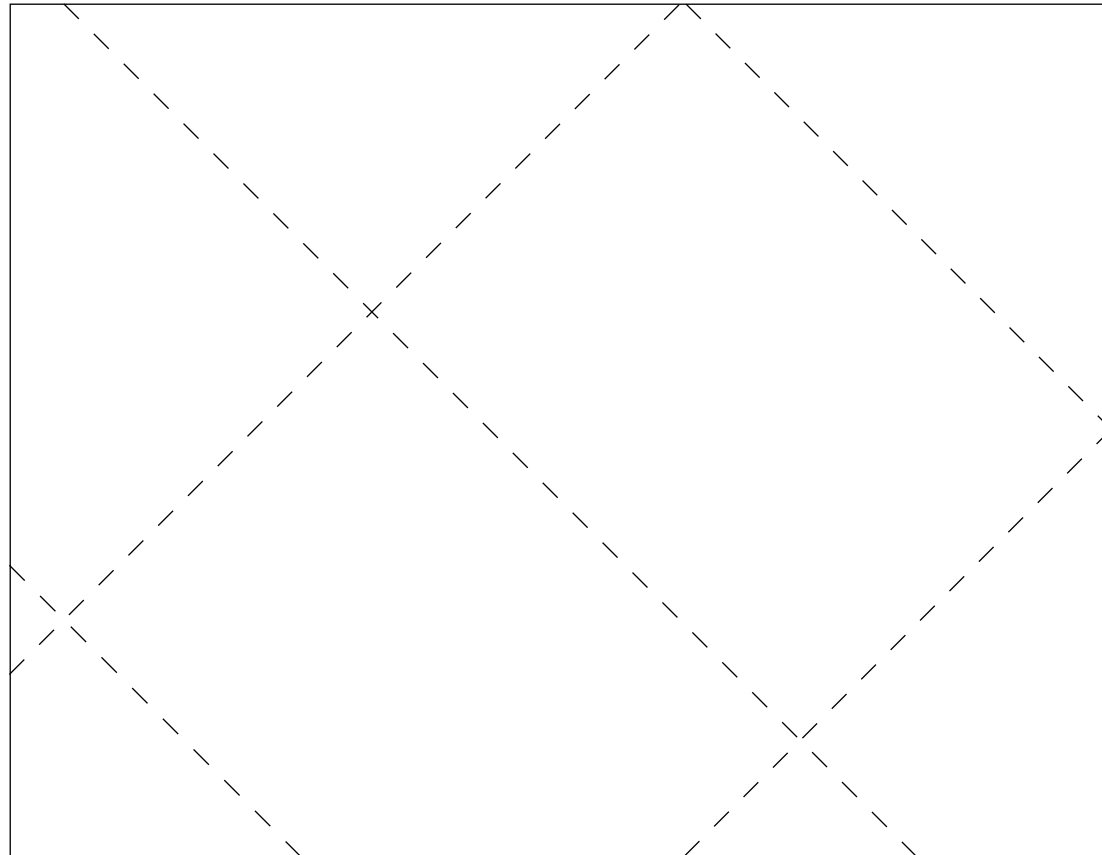

**ANDREW ZO**  
*Guest Contributor*

Graphic Designer based  
in Vancouver, Canada.

w: [andrewzo.com](http://andrewzo.com)  
t: [@andrewzo](https://twitter.com/andrewzo)

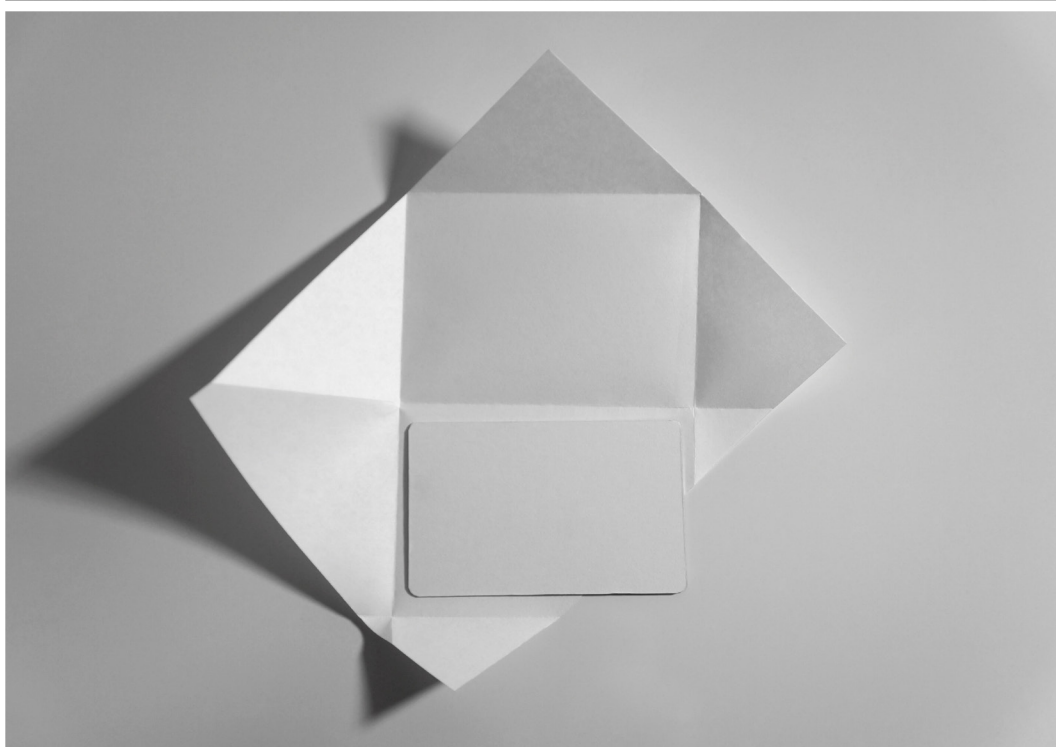
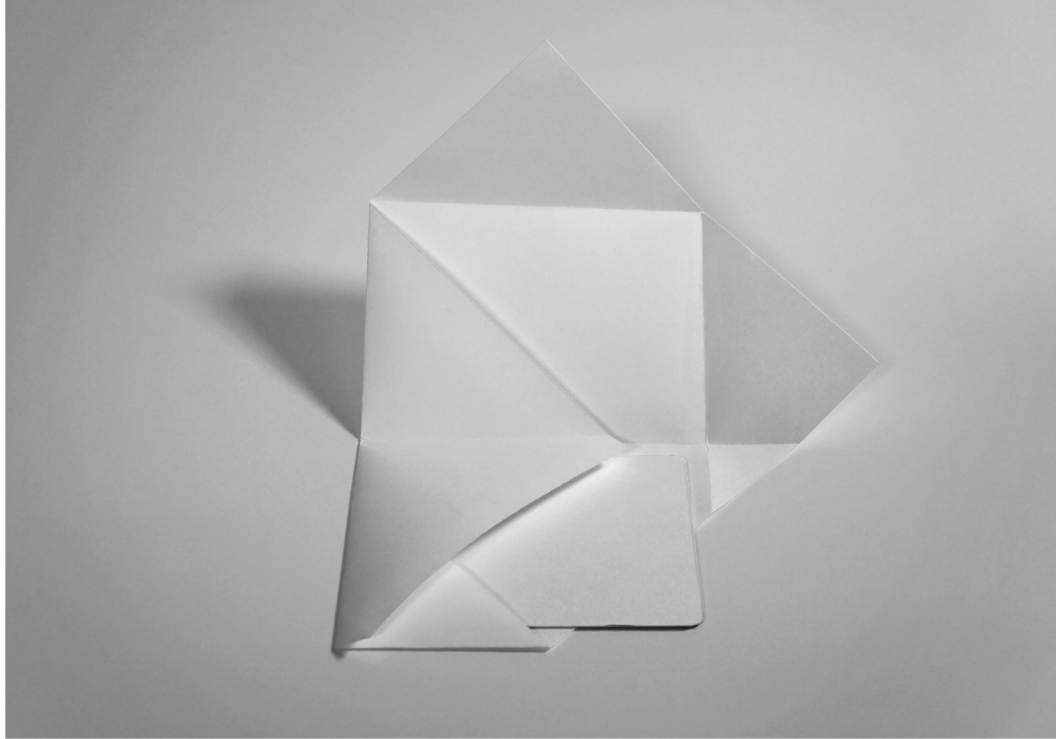
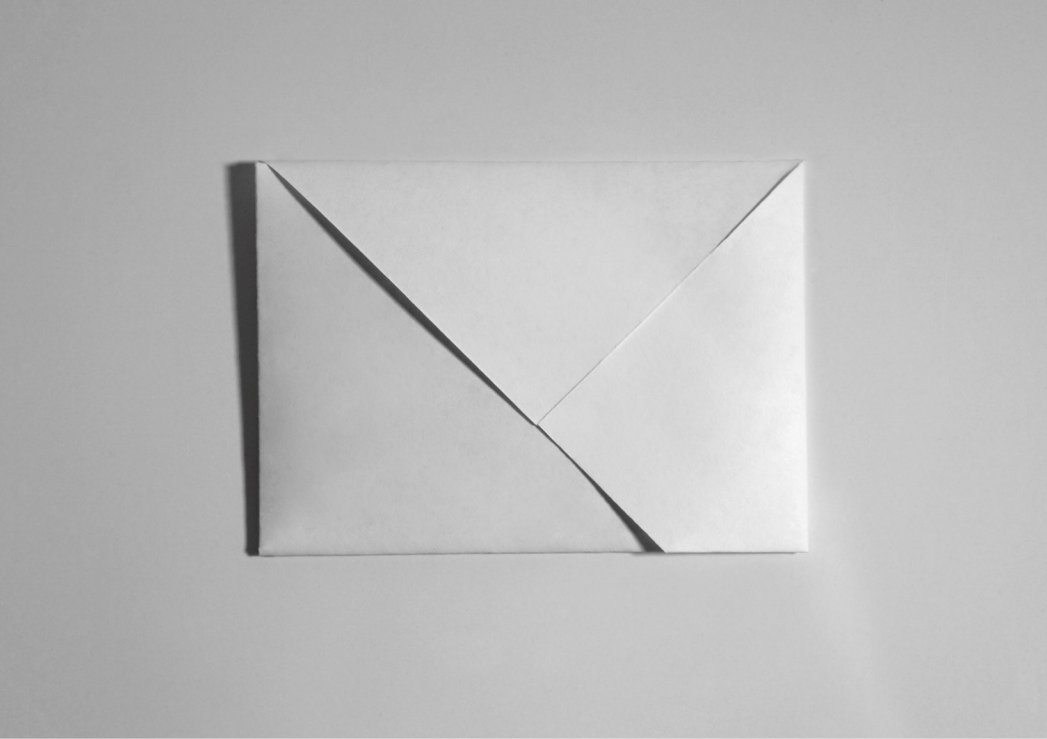

# DOWNLOAD INSTRUCTIONS

1. Click on Share, or the share icon. 
2. Click on Download.
3. Open the PDF in Illustrator to desired page.

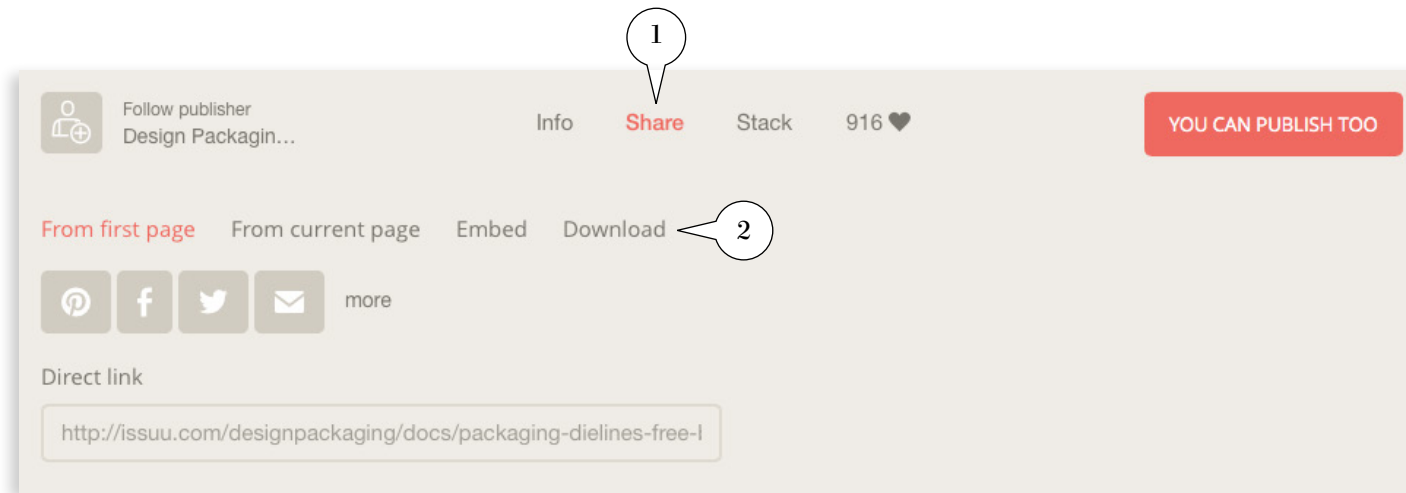

## PACKAGING & DIE LINES 2: THE DESIGNER'S BOOK OF DIE LINES

© 2015 Design Packaging, Inc. | Design Packaging Inc., 7880 East McClain Dr, Scottsdale, AZ 85260

Packaging & Dielines 2: The Designer's Book of Dielines is a free digital publication. By downloading, sharing, or embedding any portion of this publication, you agree that no part of this publication may be reproduced, distributed, or transmitted in any form or any means, including photocopying, recording, or other electronic or mechanical methods for a fee or profit. All contents in this publication must remain free of charge, with no copyright or attribution. Photography from this publication is property of Design Packaging, Inc. and cannot be used without permission.

## BOOK CREDITS



**EVELIO MATTOS,**  
Creative Director



**JOHNATHAN TURNER,**  
Structural Packaging Designer



**GEORGE BERNAL,**  
Production Artist



**ROB REPTA,**  
Senior Packaging Designer



**JULIE LUCAS,**  
Operations Manager

## SPECIAL THANKS



Established in 2007, the Dieline remains the industry's source for package design, ushering a new wave of designers and enthusiasts.

# GUEST CONTRIBUTORS



## MAT BOGUST | THINK PACKAGING | CARDBOARD ENGINEER

Mat is a structural cardboard engineer that is all about creating more than just a box, not the same packaging. THINK Packaging began a cardboard revolution, challenging the opinions of clients that standard templates were 'good enough'. Well, they're not. Not to Mat, or to the team at Design Packaging, which is why he's on a quest to put sexy

back into packaging. Mat soon found himself in New Zealand and setup THINK Packaging in May 2010, and has been working with companies not only in NZ, but worldwide as their packaging/form specialist. Mat has had the opportunity to design for some of Europe's leading production houses, agencies, brands and even a royal wedding.



## ANDREW ZO | PACKAGING DESIGNER

Andrew is an award-winning, innovative packaging designer based in Vancouver, Canada. He uses paper to create delightful unboxing experiences for large and small businesses. You can find Andrew's work featured on various internationally acclaimed design sites and books. His most well known design is the flat engagement ring case, Clifton, which was

featured on prestigious design websites around the world as well as various television programs. Andrew began playing with paper when he was young. His childhood creation included: a mighty strong cardboard fortress, a flower for his mother that used up an entire bottle of glue and hundreds of origami boxes made from Ikea catalogs.

# BECOME A CONTRIBUTOR!

In an industry where generic packaging structures riddle the world of retail, we're out to rebel. We believe that packaging design should be more than graphics on a basic box. Packaging structures should look distinct, and create a signature consumer experience.

We have already begun the third installment of Packaging & Dielines: The Designer's Book of Packaging Dielines for Fall 2016. We want to hear from you!

The digital publication is free to use, and free to submit!

SUBMITTAL DEADLINE: APRIL 2016

1. Click on the link below .
2. Include images and short description in the email request.
3. Return the submittal form with vector dielines and you're done!

[REQUEST SUBMITTAL FORM](#)

DISCLAIMER: By submitting dielines, the entrant(s) assign the publication rights to Design Packaging, TheDieline.com and Dieline Media, for the works submitted. The entrant agrees to take all responsibility for any claims made against Design Packaging, TheDieline.com and Dieline Media in the event of a dispute or litigation with possible claimant(s) or others. We cannot be held responsible for any problem of reproduction and/or designation of the works. By entering dielines, you agree that the dielines are free of royalties, and can be used by anyone.

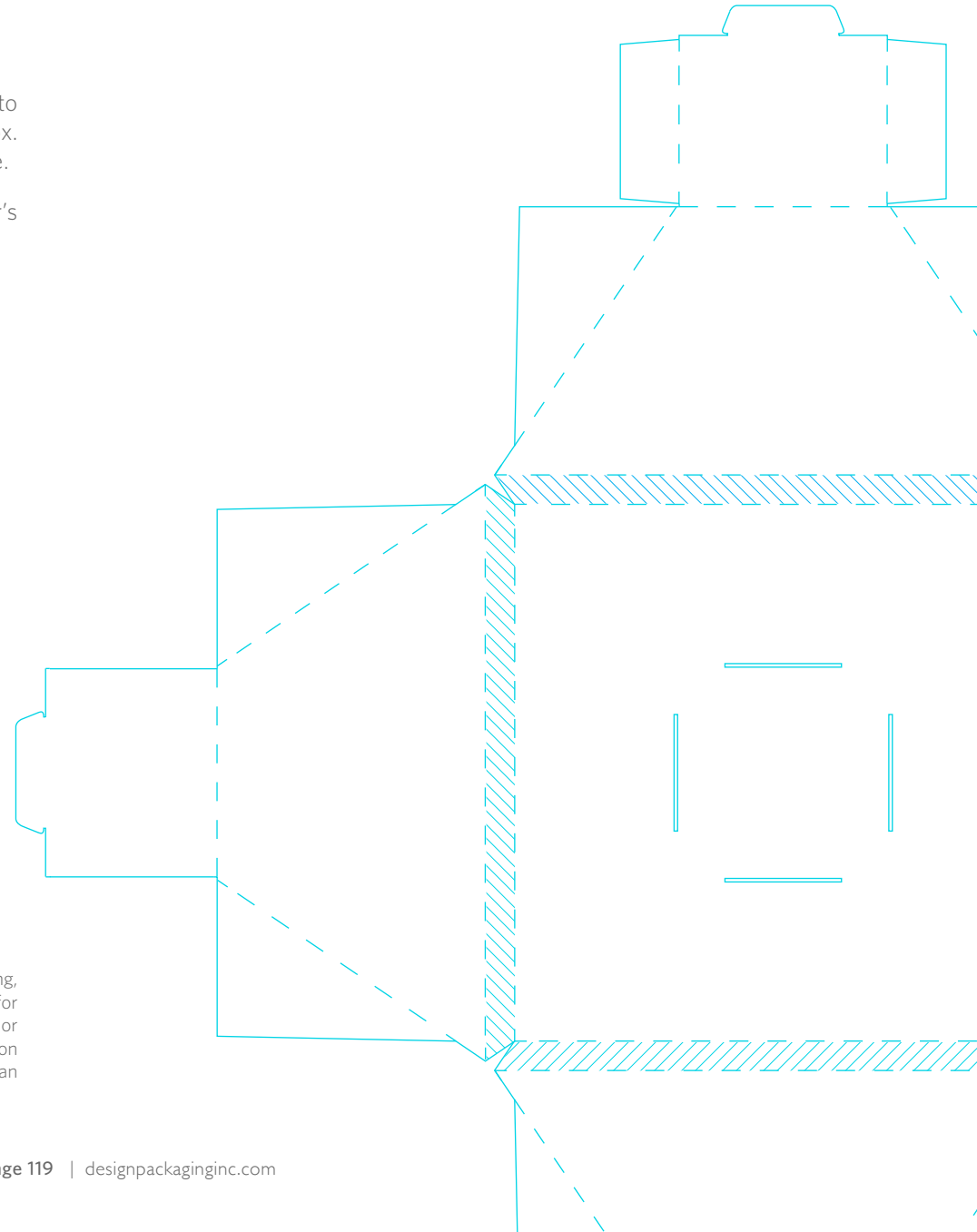

LET'S CONNECT.



DESIGN PACKAGING

EST. 1985